

# INSTRUCTIONS FOR INSTALLATION OF ONE SIDED DEADLOCK OSD100

## 1. MARK DOOR

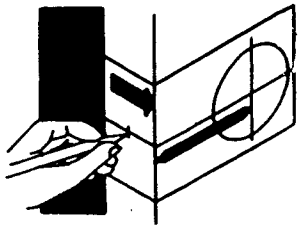

A. Fold and apply template to high edge of door bevel and mark center of door edge for 1" (25mm) latch hole as indicated of template at the desired height from the floor.

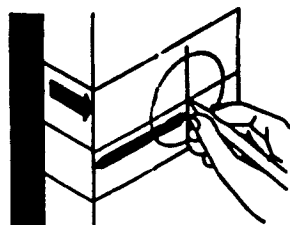

B. Mark center hole on door face through guide on template. For either 2-3/8" (60mm) or 2-3/4" (70mm) backset.

## 2. DRILL HOLES



In edge of door, drill a 1" (25mm) diameter latch hole where previously marked. Drill 4" (102mm) deep. Then drill as was mark a 1-5/8" (41mm) hole making sure not to break through to opposite side. Drill just past the 1" (25mm) diameter hole.

## 3. INSTALL LATCH

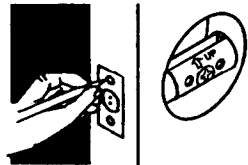

A. Insert latch into hole keeping it parallel to face of door. Mark outline and remove latch.

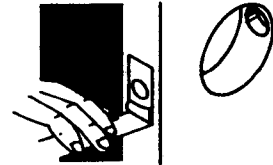

B. Chisel 1/8" (3mm) deep or until face plate of Deadbolt is flush with door edge.

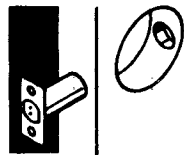

C. Install deadbolt latch in "up" position into hole as shown on latch. Insert and tighten screws.

**IMPORTANT:** Do not hammer on latch if bolt is extended.

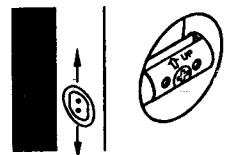

D. For round face deadbolt, simply press flush to door edge. Bolt must be vertically aligned with door edge as indicated by arrow.

## 4. INSTALL THUMB TURN ASSEMBLY

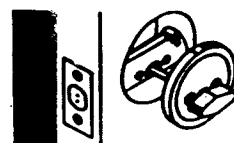

A. Align torque blade of thumb turn assembly with crank in latch and press flush against door.

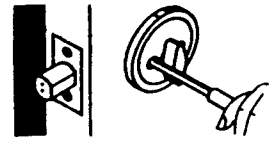

B. Rotate turnpiece to locked position (bolt extended). Insert two oval head mounting screws and tighten.

## 5. INSTALL STRIKE

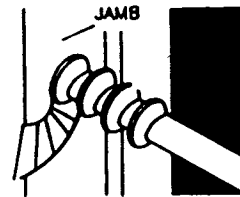

A. Locate strike plate by marking end of bolt with marking crayon or lipstick. Close door and operate bolt back and forth several times to mark the jamb. Locate the center of spot and drill a 1" (25mm) hole a minimum of 1" (25mm) deep. (Lock will not function properly if hole is not deep enough.)

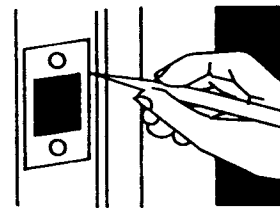

B. Center strike plate over hole and mark around outside with pencil or scribe. With chisel cut out jamb to a depth of 1/16" (1.5mm) or until strike plate can be installed flush.

Insert and tighten two flat head wood screws.

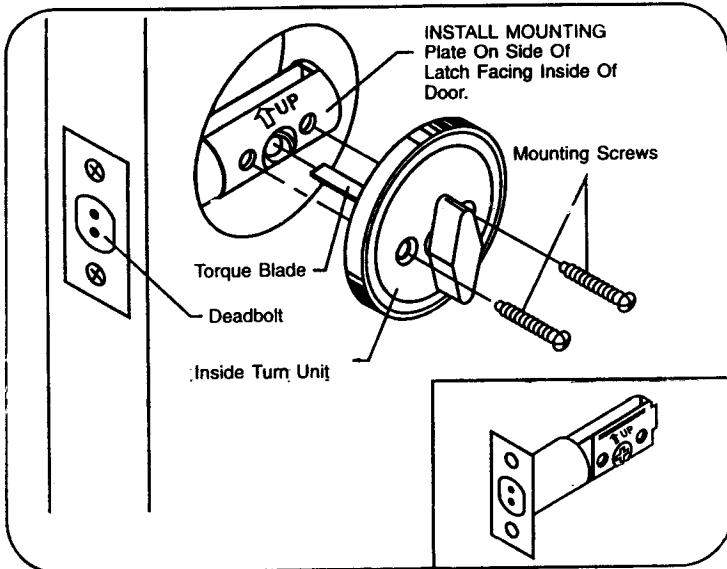

MINIMUM DOOR THICKNESS 1-3/8" (35mm)

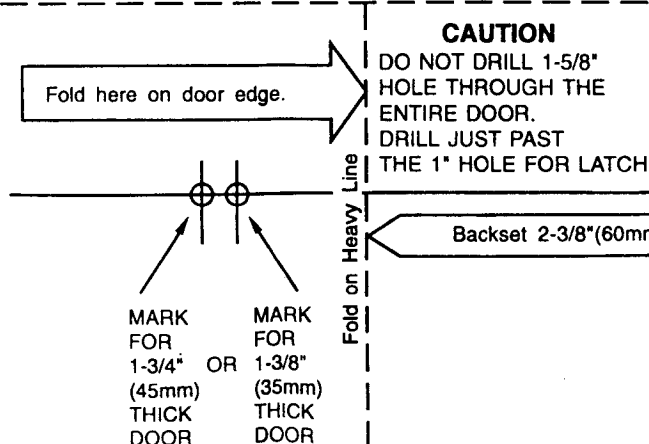

MARK CENTER OF 1-5/8" (41mm) HOLE ON DOOR FACE

CAUTION: DO NOT DRILL 1-5/8" (41mm) HOLE THROUGH ENTIRE DOOR. (READ INSTRUCTIONS CAREFULLY)