

CAL-ROYAL

INSTRUCTIONS FOR INSTALLING CHALLENGER SERIES
TUBULAR LOCKSET

PRODUCTS, INC.

JUNO AND FRANKLIN DESIGNS REVERSIBLE
FOR ENTRANCE, PRIVACY AND PASSAGE AND NON HANDED

TS

**CHALLENGER SERIES ARE PACKED UNASSEMBLED INSIDE BOX
FOR CONVENIENCE & QUICK INSTALLATION.**

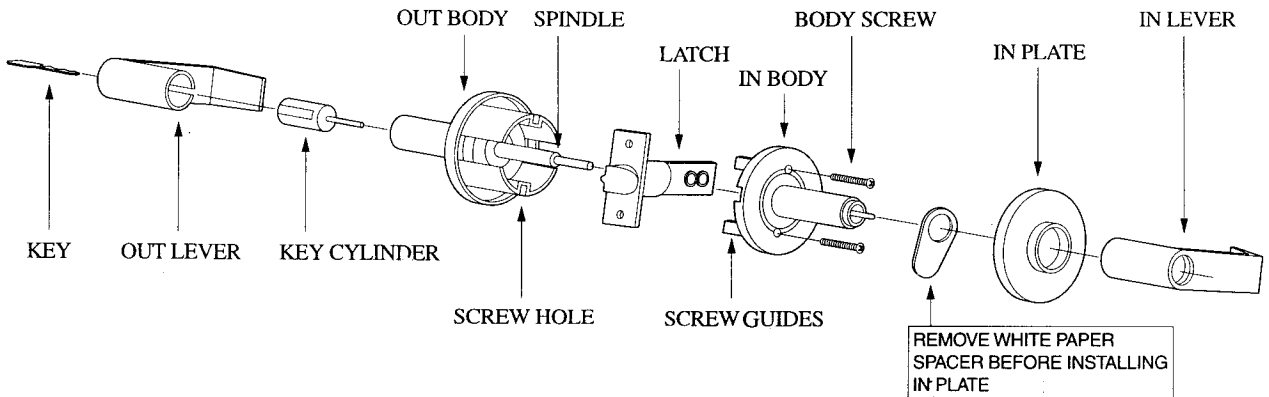

(1) MARK DOOR WITH TEMPLATE

- * HEIGHTLINE -38" FROM FLOOR.
- * FOLD TEMPLATE OVER EDGE OF DOOR, CENTERING ON HEIGHTLINE.
- * MARK CENTERS OF 7/8" AND 2 1/8" HOLES.
- * LEVER HOLE CENTER FOR BACKSET - 2 3/8" (60MM) OR 2 3/4" (70MM) AS DESIRED.

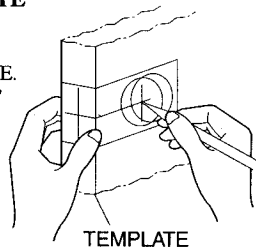

TEMPLATE

(2) BORE TWO HOLES

- * BORE 2 1/8" HOLE THROUGH DOOR, AND 7/8" HOLE INTO EDGE OF DOOR AT POINTS MARKED ON TEMPLATE.

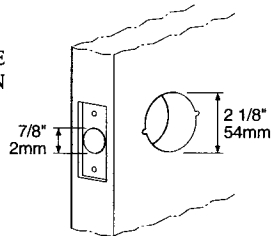

(3) CHISEL CUTOUT FOR SQUARE LATCH FRONT.

- * CHISEL WOOD TO FIT LATCH FRONT WITH DOOR EDGE.
- * INSTALL LATCH WITH BEVELED SIDE OF GUARD BOLT TOWARD DOOR JAMB.

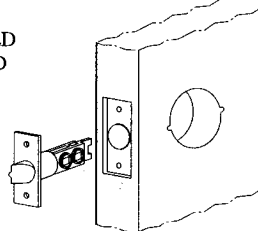

(4) INSTALL FIRE CUP

INSERT CUP WITH LARGE OPEN END TOWARD OUTSIDE OF DOOR.

- * NOTE: FAILURE TO USE THE FIRE CUP, AND UL MARKED LATCH WILL INVALIDATE UL LISTING.

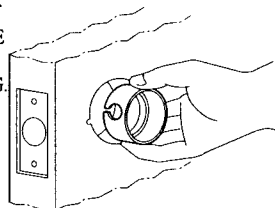

(5) INSTALL LATCH UNIT.

INSERT LATCH UNIT IN DOOR. (BE SURE BEVEL EDGE OF BOLT FACES STRIKE PLATE.) ATTACH WITH TWO SCREWS SUPPLIED.

NOTE: PREPREPPED DOOR WITH 1" HOLE REQUIRES LATCH SLEEVE.

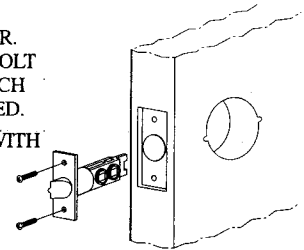

(6) INSTALL OUTSIDE LEVER & BODY

INSERT OUTSIDE LEVER & BODY WITH SQUARE SPINDLE INTO LATCH.

- * WARNING: LOCKING BAR SHAFT MUST BE IN HORIZONTAL POSITION AS IN DRAWING.

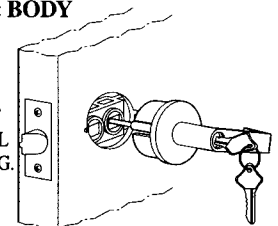

- * ADJUSTABLE BACKSET (2 3/8" ~ 2 3/4")

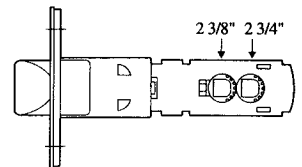

(7) INSTALL INSIDE UNIT

1. PLACE INSIDE UNIT IN POSITION ONTO SPINDLE. INSERT AND TIGHTEN MOUNTING SCREWS.
2. DISASSEMBLE IN LEVER.
3. ASSEMBLE IN PLATE AND IN LEVER.

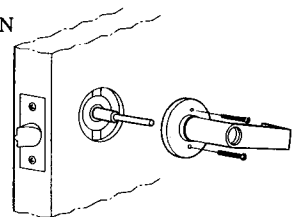

(8) INSTALL STRIKE

