



## 45-RIM & F45-RIM, Rim Type Panic And Fire Exit Devices (ADA) 45-SVR & F45-SVR, Vertical Rod Panic And Fire Exit Devices (ADA) 4500 Series, Cross Bar Narrow Stile, ANSI A156.3, Grade 1



### Features & Construction

- ◆ Americans with Disability Act (ADA) compliant. 5lbs opening force on ADA products only
- ◆ ANSI A156.3, Grade 1 Exit Device in Cross Bar Narrow Stile Rim & Surface Vertical Rod designs
- ◆ Trims are thru-bolted for additional security
- ◆ Conforms and meets ADA Regulations (ADA products only)
- ◆ UL305 & UL10C Fire Exit Hardware. 3 hours
- ◆ (A) label rating on pairs of doors up to 8'0" x 8'0" swinging in same or opposite directions
- ◆ All inside components are made up of high rust-resistant alloy or heavily electroplated steel
- ◆ High shock resistant latching mechanical design for protection from vandalism
- ◆ Uncompromising security and safety in single and double fire exit doors
- ◆ Available in standard functions. Lever and escutcheon trims are Grade 1 construction trims

# 45-RIM & F45-RIM Series

## GRADE 1 Cross Bar Narrow Stile Rim Type Exit Device



**LIFETIME WARRANTY**

**BHMA™ CERTIFIED**  
Be Safe. Be Secure. Look for the Mark.



**\*Americans with Disability Act (ADA) compliant  
5 lbs opening force on ADA Series only**

**\*Refer to the Price List for Stock Sizes and Finishes**

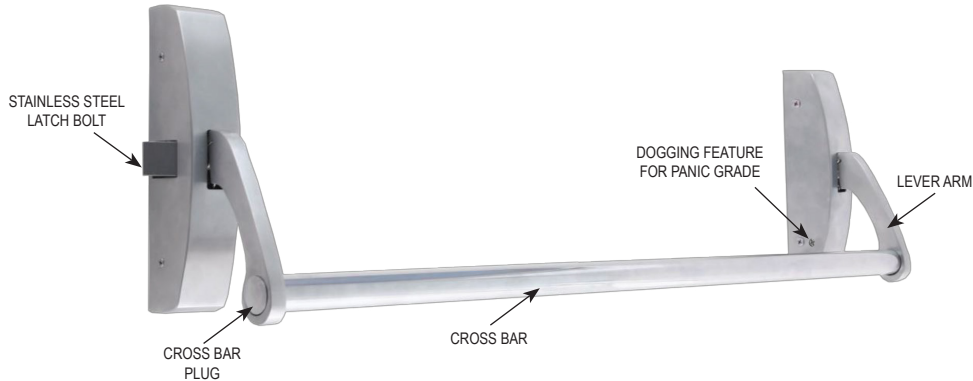

### Specifications

|                               |   |
|-------------------------------|---|
| <b>For Doors.....</b>         | 1 3/4" - 2 1/4" thick standard. 3 5/16" minimum stile width for single door application using standard roller strike. 4 21/64" minimum stile width required for double door application with overlapping strike.              |
| <b>Chassis.....</b>           | Steel material for Panic and Fire Grade.  |
| <b>Cover.....</b>             | Aluminum material   |
| <b>Mounting.....</b>          | Furnished with wood and machine screws. Available thru-bolts on request.<br><b>(8) Thru-Bolts are included and standard packaging on fire rated devices</b>   |
| <b>Hand.....</b>              | Handed. Easily field reversible. Specify at time of order LHR, RHR for convenience  |
| <b>Latch Bolt.....</b>        | Stainless Steel S304 material, 1 1/16" throw  |
| <b>ANSI Standard.....</b>     | A156.3, Grade 1   |
| <b>Cross Bar .....</b>        | Aluminum material; 1" diameter, 0.058" thick  |
| <b>Strike.....</b>            | (610) Roller Rim Strike   |
| <b>Dogging Feature.....</b>   | Allen-type key furnished standard on non-fire labeled devices   |
| <b>Mullion.....</b>           | Available   |
| <b>UL and ULC Listed.....</b> | 45-RIM Series for Panic. F45-RIM Series for Fire Exit hardware for all types of 4' x 8' single doors and 8' x 8' double doors for up to 3 hour fire labeled installations. Conforms to standards UL10C and UBC 7-2-1997 codes |
| <b>Finish.....</b>            | Aluminum (Alum), Dark Bronze Duranodic (Duro)   |

### DIMENSIONS

|  |   |
|--|---|
| <b>Touchbar height to finished floor</b> | 41" (1041 mm) at center                                 |
| <b>Touchbar projection</b>               |   |
| Neutral                                  | 5 13/64" (132 mm)                                       |
| Depressed                                | 4 7/32" (107mm)   |
| <b>Main case</b>                         | 8 55/64" x 1 17/32" x 2 13/64" (225 mm x 39 mm x 56 mm) |
| <b>End case</b>                          | 8 55/64" x 1 17/32" x 2 13/64" (225 mm x 39 mm x 56 mm) |

| MODEL                 | ACTUAL LENGTH | DOOR SIZE            | CROSS BAR LENGTH |
|-----------------------|---------------|----------------------|------------------|
| 45-RIM-36, F45-RIM-36 | 34 19/64"     | Up to 36" door width | 33 17/64"        |
| 45-RIM-48, F45-RIM-48 | 46 19/64"     | Up to 48" door width | 45 9/32"         |

# 45-SVR & F45-SVR Series



## GRADE 1 Cross Bar Narrow Stile Surface Vertical Rod Exit Device

**LIFETIME WARRANTY**

**BHMA™ CERTIFIED**  
Be Safe. Be Secure. Look for the Mark.



### Specifications

- For Doors.....** 1 3/4"- 2 1/4" thick standard.  
1 3/4" minimum stile width for single or double door application.
- Top & Bottom Chassis.....** Steel material for Panic and Fire Grade.
- Cover.....** Aluminum material
- Mounting.....** Furnished with wood and machine screws.  
**(12) Thru-Bolts are included and standard packaging on fire rated devices.**
- Hand.....** Non-Handed. Reversible
- Latch Bolt.....** Stainless Steel S304 material
- Rod Guide.....** Stainless Steel S304 material
- ANSI Standard.....** A156.3, Grade 1
- Cross Bar.....** Aluminum material; 1" diameter, 0.058" thick
- Strike.....** (610) Roller Rim Strike, (620) Top Strike, (233) Bottom Strike, (221) Handicap Bottom Strike
- Dogging Feature.....** Allen-type key furnished standard on non-fire labeled devices
- UL and ULC Listed.....** 45-SVR Series for Panic. F45-SVR Series for Fire Exit hardware for all types of 4' x 8' single doors and 8' x 8' double doors for up to 3 hour fire labeled installations. Conforms to standards UL10C and UBC 7-2-1997 codes
- Finish.....** Aluminum (Alum), Dark Bronze Duranodic (Duro)

**\*Americans with Disability Act (ADA) compliant  
5 lbs opening force on ADA Series only  
\*Refer to the Price List for Stock Sizes and Finishes**

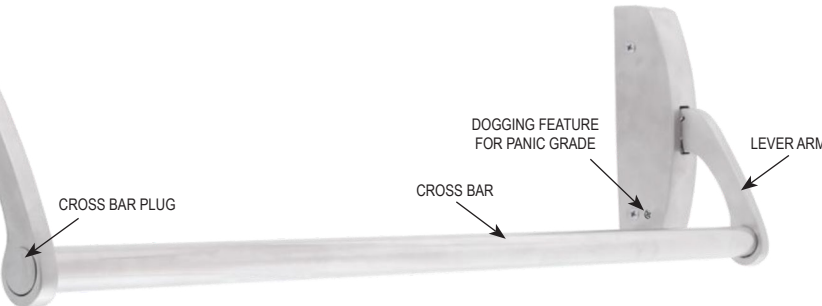

### DIMENSIONS

|  |   |
|--|---|
| <b>Touchbar height to finished floor</b>             | 41" (1041 mm) at center   |
| <b>Touchbar projection</b>                           |   |
| Neutral  | 5 13/64" (132 mm)   |
| Depressed  | 4 7/32" (107mm)   |
| <b>Main case</b>                                     | 8 55/64" x 1 17/32" x 2 13/64" (225 mm x 39 mm x 56 mm)               |
| <b>End case</b>                                      | 8 55/64" x 1 17/32" x 2 13/64" (225 mm x 39 mm x 56 mm)               |
| <b>Panic grade top &amp; bottom latch case</b>       | 4 11/16" x 1 1/16" x 1 47/64" (119 mm x 27 mm x 44 mm)                |
| <b>Fire grade top &amp; bottom latch case</b>        | 4 11/16" x 1 1/16" x 1 47/64" (119 mm x 27 mm x 44 mm)                |
| <b>Top and bottom rod length for 36" x 84" doors</b> | Top rod 34 27/32" (885 mm), bottom rod 33 35/64" (852 mm)             |
| <b>Top and bottom rod length for 48" x 96" doors</b> | Top rod 34 27/32" + 12" ETR (910.4 mm), bottom rod 33 35/64" (852 mm) |
| <b>Vertical Rods</b>                                 | 15/32" (11.9 mm) round tubing   |

| MODEL                     | ACTUAL LENGTH | DOOR SIZE            | CROSS BAR LENGTH |
|---------------------------|---------------|----------------------|------------------|
| 45-SVR-3684, F45-SVR-3684 | 34 19/64"     | Up to 36" door width | 33 17/64"        |
| 45-SVR-4896, F45-SVR-4896 | 46 19/64"     | Up to 48" door width | 45 9/32"         |

# LBR45-SVR & LBRF45-SVR Series

## GRADE 1 Cross Bar Narrow Stile SVR Type Exit Device, Less Bottom Rod (LBR)



### Specifications

- For Doors**..... 1 3/4" - 2 1/4" thick standard.  
1 3/4" minimum stile width for single or double door application.
- Top Chassis**..... Steel material for Panic and Fire Grade.
- Cover**..... Aluminum material
- Mounting**..... Furnished with wood and machine screws.  
**(10) Thru-Bolts are included and standard packaging on fire rated devices.**
- Hand**..... Non-Handed. Reversible
- Latch Bolt**..... Stainless Steel S304 material
- Rod Guide**..... Stainless Steel S304 material
- ANSI Standard**..... A156.3, Grade 1
- Cross Bar**..... Aluminum material; 1" diameter, 0.058" thick
- Strike**..... (620) Top Strike standard
- Auxiliary Fire Latch**..... Stainless Steel S304 material. Strike hole plug is included in the standard packaging (for fire rated devices only).
- Dogging Feature**..... Allen-type key furnished standard on non-fire labeled devices
- UL and ULC Listed**..... 45-SVR Series for Panic. F45-SVR Series for Fire Exit hardware for all types of 4' x 8' single doors and 8' x 8' double doors for up to 3 hour fire labeled installations. Conforms to standards UL10C and UBC 7-2-1997 codes
- Finish**..... Aluminum (Alum), Dark Bronze Duranodic (Duro)

**\*Americans with Disability Act (ADA) compliant  
5 lbs opening force on ADA Series only**

**\*Refer to the Price List for Stock Sizes and Finishes**

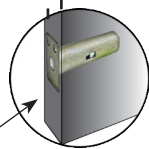
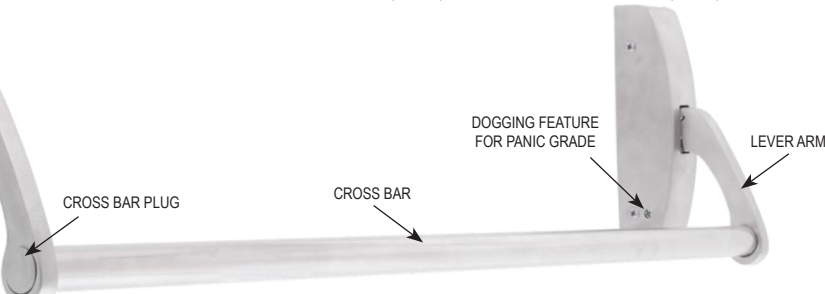
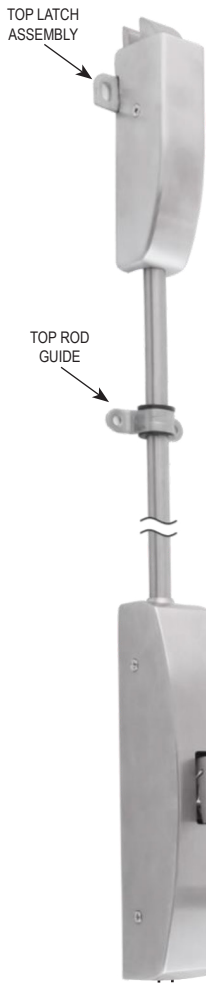

### DIMENSIONS

|   |   |                      |                         |
|---|---|----------------------|-------------------------|
| <b>Touchbar height to finished floor</b>  | 41" (1041 mm) at center                                 |                      |                         |
| <b>Touchbar projection</b>                |   |                      |                         |
| Neutral                                   | 5 13/64" (132 mm)                                       |                      |                         |
| Depressed                                 | 4 7/32" (107mm)   |                      |                         |
| <b>Main case</b>                          | 8 55/64" x 1 17/32" x 2 13/64" (225 mm x 39 mm x 56 mm) |                      |                         |
| <b>End case</b>                           | 8 55/64" x 1 17/32" x 2 13/64" (225 mm x 39 mm x 56 mm) |                      |                         |
| <b>Panic grade top latch case</b>         | 4 11/16" x 1 1/16" x 1 47/64" (119 mm x 27 mm x 44 mm)  |                      |                         |
| <b>Fire grade top latch case</b>          | 4 11/16" x 1 1/16" x 1 47/64" (119 mm x 27 mm x 44 mm)  |                      |                         |
| <b>Top rod length for 36" x 84" doors</b> | Top rod 34 27/32" (885 mm)                              |                      |                         |
| <b>Top rod length for 48" x 96" doors</b> | Top rod 34 27/32" + 12" ETR (910.4 mm)                  |                      |                         |
| <b>Vertical Rods</b>                      | 15/32" (11.9 mm) round tubing                           |                      |                         |
| <b>MODEL</b>                              | <b>ACTUAL LENGTH</b>                                    | <b>DOOR SIZE</b>     | <b>CROSS BAR LENGTH</b> |
| LBR45-SVR-3684, LBRF45-SVR-3684           | 34 19/64"   | Up to 36" door width | 33 17/64"               |
| LBR45-SVR-4896, LBRF45-SVR-4896           | 46 19/64"   | Up to 48" door width | 45 9/32"                |

# Trim Selection

## CLUTCH LEVER ESCUTCHEON



### CONSTRUCTION

- **Non-Ferrous Alloy Material**
- Clutch Mechanism
- Double Heavy Duty Spring Support to prevent sagging and enhance operation
- Grade 1, Thru-Bolted design. Non-Handed design.
- Easily field reversible
- Includes Adjustable Heavy Duty Steel Spindle.
- Available for Fire and Non-Fire Rated Rim and Vertical Rod Exit Devices
- Standard 6-Pin Schlage "C" Mortise Cylinder included



### DOOR THICKNESS

- Standard 1 3/4" to 2 1/4". Optional 1 3/8".
- Use Adjustable Spindle for 1 3/4", 2, 2 1/4" door thickness.
- Spindle for 1 3/8" door thick also included in packaging.

### ESCUTCHEON DIMENSIONS

- 1 5/8" width x 8 5/8" length
- Lever length: 5"

Anti-Microbial Coating available in US26D Only. Use part # **"ANTB-TRIM"** when ordering.

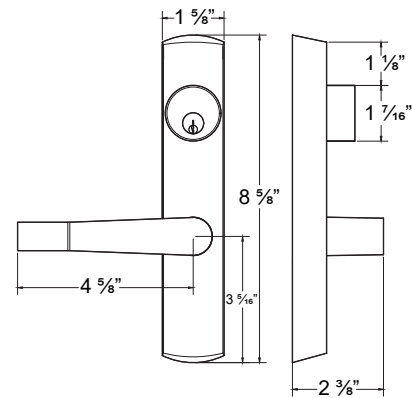

#### ESC45-00

● ICES45-00

● ICSCESC45-00

#### ENTRANCE

Clutch Entrance, key locks or unlocks escutcheon trim. ANSI Function (08)  
Operates as classroom function

#### ESC45-05

● ICES45-05

● ICSCESC45-05

#### STOREROOM

Clutch Storeroom, key unlocks lever, lever retracts latch bolt, otherwise always locked. ANSI Function (09)

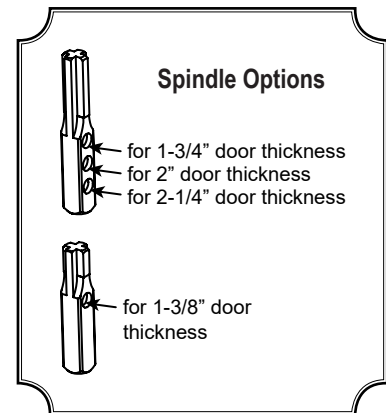

#### ESC45-30

#### PASSAGE

Trim always operable and free.  
ANSI Function (14)

#### ESC45-40

#### DUMMY

Dummy Escutcheon trim.  
ANSI Function (02)

**KEYWAY:** 6-Pin solid brass "C" keyway Mortise Cylinder standard. Optional: Schlage E, Schlage C-K, Russwin D1-2-3-4, Corbin 59/60, Sargent LA-LB-LC, Falcon/Weiser E, Arrow A, Yale 8, Yale GA and Kwikset. Can also accept Medeco, Assa, Kaba and **Cal-Royal HSK High Security** Cylinders.

● (IC) **INTERCHANGEABLE CORE** locks will accept compatible 6 or 7-Pin cores with **BEST, FALCON and ARROW**.

● (ICSC) **INTERCHANGEABLE CORE** available with **Schlage Full Size Format**. Corbin, Sargent and Yale format also available.

# Strike & Accessories



**Strike for use with 45-RIM & F45-RIM Exit Devices**

**610**  
Roller Rim Strike,  
surface applied.  
Standard Packaging.

**Additional Accessories**

**LFF**  
Lock front filler

**SF**  
Strike filler

**EXTROD66-12** – 12" Extension Rod  
**EXTROD66-24** – 24" Extension Rod

**Strike for use with 45-SVR & F45-SVR Exit Devices**

**620**  
Top Strike.  
Standard packaging.

**Overlapping Strike**

**N251**  
Surface applied. Used on inactive leaf for device on active leaf of pair of doors without mullion.

**221**  
Handicap Bottom Strike.  
Applied to surface of floor  
or to a flat threshold.  
Standard packaging.

**GLASS BEAD SHIM KITS**

**201**  
for 45-RIM  
& F45-RIM,  
1/8" thick

**212**  
for 45-SVR  
& F45-SVR,  
1/8" thick

**233**  
Bottom strike.  
Flush mounting stainless steel.  
Furnished with expansion shields.  
Requires mortise in the floor.