

GENESYS Series

HEAVY DUTY CYLINDRICAL LEVERSETS WITH CLUTCH,
ANSI - A156.2, SERIES 4000, GRADE 1

Optional Interchangeable Core for **BEST, FALCON & ARROW**

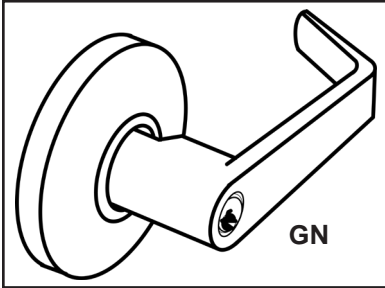

NON-STOCK FINISHES AND DESIGNS AVAILABLE WITH FACTORY LEAD TIME AND SUBJECT TO MINIMUM ORDER

FUNCTIONS	ANSI	ITEM#	FINISH					PCS / MC
Entrance	F109	CGN00	US26D	US32D	US1	US10B, 10BE, 3, 10, 4	US26	10
		⌘ ICCGN00						
Entrance Push Button Lock	F82	CGN01						
		⌘ ICCGN01						
Store lock - Non Clutch (keyed Dbl. cyl.)	F91	GN02						
		⌘ ICCGN02						
Classroom	F84	CGN03						
		⌘ ICCGN03						
Communicating (keyed Dbl. cyl.)	F80	CGN04						
		⌘ ICCGN04						
Storeroom	F86	CGN05						
		⌘ ICCGN05						
Vestibule	F88	CGN06						
		⌘ ICCGN06						
Classroom / Intruder	F110	CGN07						
		⌘ ICCGN07						
Dormitory (Non-Clutch)	F90	GN101						
Institution (keyed Dbl. cyl.)	F87	CGN09						
		⌘ ICCGN09						
Privacy	F76	CGN20						
Hospital Privacy	---	HCGN20						
Passage	F75	GN30						
Exit	F89	GN50						
Single Dummy	----	GN40						20

⌘ (IC) Indicates function available with Best, Falcon and Arrow Interchangeable Core.

HEAVY DUTY CYLINDRICAL LEVERSETS WITH CLUTCH ANSI - A156.2, SERIES 4000, GRADE 1

Optional Interchangeable Core for **BEST, FALCON & ARROW**

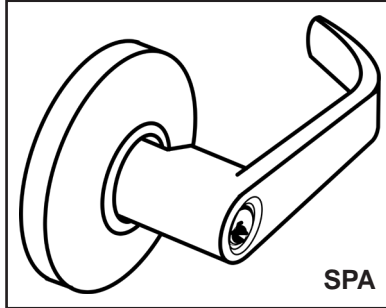
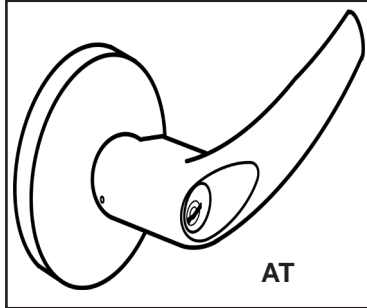

NON-STOCK FINISHES AND DESIGNS AVAILABLE WITH FACTORY LEAD TIME AND SUBJECT TO MINIMUM ORDER

FUNCTIONS	ANSI	ITEM#		FINISH			PCS / MC
Entrance	F109	CAT00	CSPA00	US26D	US1	US10B, 10BE, 3, 10, 26, 4	10
		⊗ ICCAT00	⊗ ICCSPA00				
Entrance Push Button Lock	F82	CAT01	CSPA01				
		⊗ ICCAT01	⊗ ICCSPA01				
Store lock - Non Clutch (keyed Dbl. cyl.)	F91	AT02	SPA02				
		⊗ ICAT02	⊗ ICSPA02				
Classroom	F84	CAT03	CSPA03				
		⊗ ICCAT03	⊗ ICCSPA03				
Communicating (keyed Dbl. cyl.)	F80	CAT04	CSPA04				
		⊗ ICCAT04	⊗ ICCSPA04				
Storeroom	F86	CAT05	CSPA05				
		⊗ ICCAT05	⊗ ICCSPA05				
Vestibule	F88	CAT06	CSPA06				
		⊗ ICCAT06	⊗ ICCSPA06				
Classroom / Intruder	F110	CAT07	CSPA07				
		⊗ ICCAT07	⊗ ICCSPA07				
Institution (keyed Dbl. cyl.)	F87	CAT09	CSPA09				
		⊗ ICCAT09	⊗ ICCSPA09				
Privacy	F76	CAT20	CSPA20				
Hospital Privacy	---	HCAT20	HCSPA20				
Passage	F75	AT30	SPA30				
Exit	F89	AT50	SPA50				
Single Dummy	----	AT40	SPA40	20			

⊗ (IC) Indicates function available with Best, Falcon and Arrow Interchangeable Core.

HEAVY DUTY CYLINDRICAL LEVERSETS WITH CLUTCH ANSI - A156.2, SERIES 4000, GRADE 1

Optional Interchangeable Core for **BEST, FALCON & ARROW**

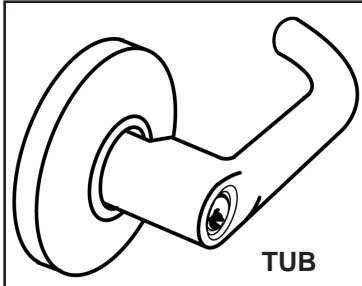

NON-STOCK FINISHES AND DESIGNS AVAILABLE WITH FACTORY LEAD TIME AND SUBJECT TO MINIMUM ORDER

FUNCTIONS	ANSI	ITEM#	FINISH		PCS / MC
Entrance	F109	CTUB00	US26D	US10B, 10BE, 3, 10, 26, 4	10
		ICCTUB00			
Entrance Push Button Lock	F82	CTUB01			
		ICCTUB01			
Store lock - Non Clutch (keyed Dbl. cyl.)	F91	TUB02			
		ICTUB02			
Classroom	F84	CTUB03			
		ICCTUB03			
Communicating (keyed Dbl. cyl.)	F80	CTUB04			
		ICCTUB04			
Storeroom	F86	CTUB05			
		ICCTUB05			
Vestibule	F88	CTUB06			
		ICCTUB06			
Classroom / Intruder	F110	CTUB07			
		ICCTUB07			
Institution (keyed Dbl. cyl.)	F87	CTUB09			
		ICCTUB09			
Privacy	F76	CTUB20			
Hospital Privacy	---	HCTUB20			
Passage	F75	TUB30			
Exit	F89	TUB50			
Single Dummy	----	TUB40	20		

IC Indicates function available with Best, Falcon and Arrow Interchangeable Core.

HEAVY DUTY CYLINDRICAL LEVERSETS WITH CLUTCH ANSI - A156.2, SERIES 4000, GRADE 1



● Optional Interchangeable Core for **BEST, FALCON & ARROW**

● Optional Full Size Interchangeable Core for **SCHLAGE, SARGENT, CORBIN/RUSSWIN**

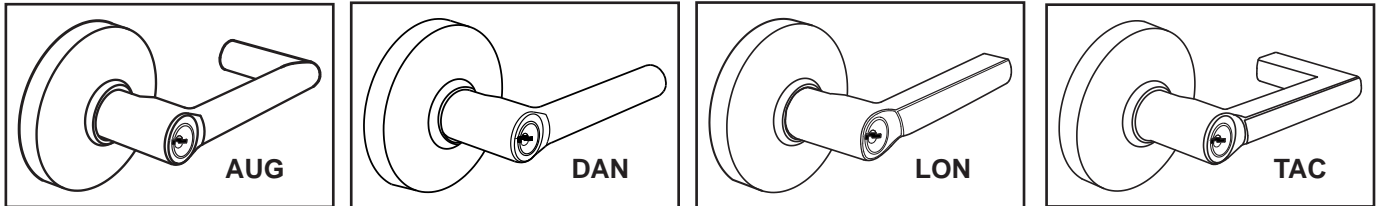

To Order: Replace "AUG" with design name when ordering. Example: CAUG00 Entrance in "TAC" design is CTAC00.

NON-STOCK FINISHES AND DESIGNS AVAILABLE WITH FACTORY LEAD TIME AND SUBJECT TO MINIMUM ORDER

FUNCTIONS	ANSI	ITEM#	FINISH				PCS / MC				
Entrance	F109	CAUG00 ●● ICSCAUG00	US26D	US10BE, 3, 10, 4	US26	US15, 1	10				
Entrance Push Button Lock	F82	CAUG01 ● ICSCAUG01									
Store lock - Non Clutch (keyed Dbl. cyl.)	F91	AUG02 ● ICSCAUG02									
Classroom	F84	CAUG03 ● ICSCAUG03									
Communicating (keyed Dbl. cyl.)	F80	CAUG04 ●● ICSCAUG04									
Storeroom	F86	CAUG05 ●● ICSCAUG05									
Vestibule	F88	CAUG06 ●● ICSCAUG06									
Classroom / Intruder	F110	CAUG07 ●● ICSCAUG07									
Dormitory (Non-Clutch)	F90	AUG101 ●									
Institution (keyed Dbl. cyl.)	F87	CAUG09 ●● ICSCAUG09									
Privacy	F76	CAUG20									
Hospital Privacy	---	HCAUG20									
Passage	F75	AUG30									
Exit	F89	AUG50									
Single Dummy	----	AUG40									20

- (IC) Indicates function available with Best, Falcon and Arrow Interchangeable Core.
- (6 Pin Only) For Schlage LFIC, prefix "ICSC" before part #. Example: "CAUG00" with "ICSC", will be "ICSCCAUG00"
• Available in US26D functions: **00, 04, 05, 06, 07, 09, 101** & US10BE functions: **00, 05**
- (6 Pin Only) For Sargent LFIC, prefix "SARIC" before part #. Example: "CAUG00" with "SARIC", will be "SARICCAUG00"
(6 or 7 Pin) For Corbin / Russwin LFIC, prefix "RUSIC" before part #. Example: "CAUG00" with "RUSIC", will be "RUSICCAUG00"
• Available in US26D only, functions: **00, 04, 05, 06, 07, 09, 101**

HEAVY DUTY CYLINDRICAL LEVERSETS WITH CLUTCH ANSI - A156.2, SERIES 4000, GRADE 1



Optional Full Size Interchangeable Core for **SCHLAGE**



LIFETIME WARRANTY

BHMA CERTIFIED
Be Safe. Be Secure. Look for the Mark.

MEETS
The Buy American Act

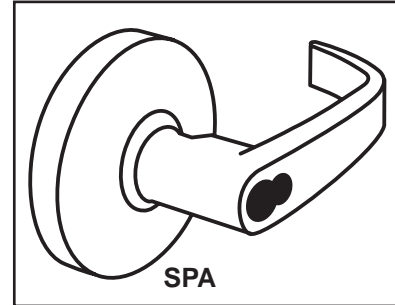
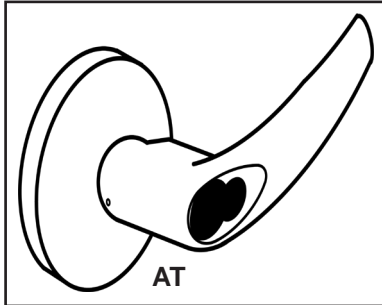
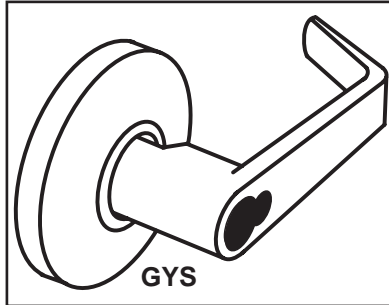

NON-STOCK FINISHES AND DESIGNS AVAILABLE WITH FACTORY LEAD TIME AND SUBJECT TO MINIMUM ORDER

FUNCTIONS	ANSI	ITEM#	FINISH			PCS / MC
			US26D	US10B, 10BE	US3, 10, 26, 4	
Entrance	F109	● ICGYS00	US26D	US10B, 10BE	US3, 10, 26, 4	10
Storeroom	F86	● ICGYS05				
Classroom	F84	● ICGYS03				
Communicating (keyed Dbl. cyl.)	F80	● ICGYS04				
Vestibule	F88	● ICGYS06				
Classroom/ Intruder	F110	● ICGYS07				
Institution (keyed Dbl. cyl.)	F87	● ICGYS09				
Dormitory (Non-Clutch)	F90	● ICGYS101				

FUNCTIONS	ANSI	ITEM#	FINISH			PCS / MC
			US26D	US10B, 10BE	US3	
Entrance	F109	● ICSCCAT00	US26D	US10B, 10BE	US3	10
Storeroom	F86	● ICSCCAT05				
Classroom	F84	● ICSCCAT03				
Communicating (keyed Dbl. cyl.)	F80	● ICSCCAT04				
Vestibule	F88	● ICSCCAT06				
Classroom/ Intruder	F110	● ICSCCAT07				
Institution (keyed Dbl. cyl.)	F87	● ICSCCAT09				
Dormitory (Non-Clutch)	F90	● ICSCCAT101				

FUNCTIONS	ANSI	ITEM#	FINISH			PCS / MC
			US26D	US10B, 10BE	US3	
Entrance	F109	● ICSCSPA00	US26D	US10B, 10BE	US3	10
Storeroom	F86	● ICSCSPA05				
Classroom	F84	● ICSCSPA03				
Communicating (keyed Dbl. cyl.)	F80	● ICSCSPA04				
Vestibule	F88	● ICSCSPA06				
Classroom/ Intruder	F110	● ICSCSPA07				
Institution (keyed Dbl. cyl.)	F87	● ICSCSPA09				
Dormitory (Non-Clutch)	F90	● ICSCSPA101				

● (ICSC) Indicates function available with Schlage Full Size Interchangeable Core. **6 PIN ONLY**

HEAVY DUTY CYLINDRICAL LEVERSETS WITH CLUTCH ANSI - A156.2, SERIES 4000, GRADE 1

Optional Full Size Interchangeable Core for **SARGENT, CORBIN/RUSSWIN, YALE**

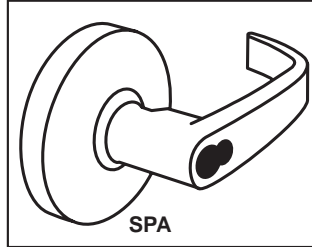
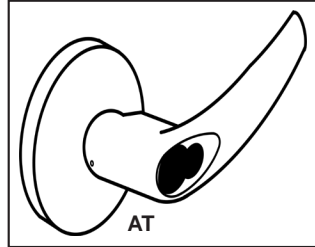
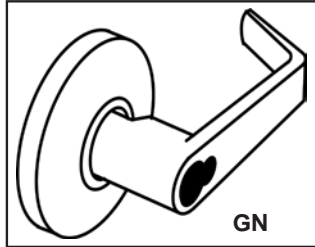

NON-STOCK FINISHES AND DESIGNS AVAILABLE WITH FACTORY LEAD TIME AND SUBJECT TO MINIMUM ORDER

FUNCTIONS	ANSI	ITEM#			FINISH	PCS / MC
		(SARIC)	(RUSIC)	(YALIC)		
Entrance	F109	(SARIC) SARICCGN00	(SARIC) SARICCAT00	(SARIC) SARICCSPA00	US26D US10B, 10BE, US3, 4, 10, 26	10
Classroom	F84	(SARIC) SARICCGN03	(SARIC) SARICCAT03	(SARIC) SARICCSPA03		
Communicating (keyed Dbl. cyl.)	F80	(SARIC) SARICCGN04	(SARIC) SARICCAT04	(SARIC) SARICCSPA04		
Storeroom	F86	(SARIC) SARICCGN05	(SARIC) SARICCAT05	(SARIC) SARICCSPA05		
Vestibule	F88	(SARIC) SARICCGN06	(SARIC) SARICCAT06	(SARIC) SARICCSPA06		
Classroom / Intruder	F110	(SARIC) SARICCGN07	(SARIC) SARICCAT07	(SARIC) SARICCSPA07		
Institution (keyed Dbl. cyl.)	F87	(SARIC) SARICCGN09	(SARIC) SARICCAT09	(SARIC) SARICCSPA09		
Dormitory (Non-Clutch)	F90	(SARIC) SARICGN101	(SARIC) SARICAT101	(SARIC) SARICSPA101		

FUNCTIONS	ANSI	ITEM#			FINISH	PCS / MC
		(RUSIC)	(RUSIC)	(RUSIC)		
Entrance	F109	(RUSIC) RUSICCGN00	(RUSIC) RUSICCAT00	(RUSIC) RUSICSPA00	US26D US10B, 10BE, US3, 4, 10, 26	10
Classroom	F84	(RUSIC) RUSICCGN03	(RUSIC) RUSICCAT03	(RUSIC) RUSICSPA03		
Communicating (keyed Dbl. cyl.)	F80	(RUSIC) RUSICCGN04	(RUSIC) RUSICCAT04	(RUSIC) RUSICSPA04		
Storeroom	F86	(RUSIC) RUSICCGN05	(RUSIC) RUSICCAT05	(RUSIC) RUSICSPA05		
Vestibule	F88	(RUSIC) RUSICCGN06	(RUSIC) RUSICCAT06	(RUSIC) RUSICSPA06		
Classroom / Intruder	F110	(RUSIC) RUSICCGN07	(RUSIC) RUSICCAT07	(RUSIC) RUSICSPA07		
Institution (keyed Dbl. cyl.)	F87	(RUSIC) RUSICCGN09	(RUSIC) RUSICCAT09	(RUSIC) RUSICSPA09		
Dormitory (Non-Clutch)	F90	(RUSIC) RUSICGN101	(RUSIC) RUSICAT101	(RUSIC) RUSICSPA101		

FUNCTIONS	ANSI	ITEM#			FINISH	PCS / MC
		(YALIC)	(YALIC)	(YALIC)		
Entrance	F109	(YALIC) YALICCGN00	(YALIC) YALICCAT00	(YALIC) YALICSPA00	US26D US10B, 10BE, US3, 4, 10, 26	10
Classroom	F84	(YALIC) YALICCGN03	(YALIC) YALICCAT03	(YALIC) YALICSPA03		
Communicating (keyed Dbl. cyl.)	F80	(YALIC) YALICCGN04	(YALIC) YALICCAT04	(YALIC) YALICSPA04		
Storeroom	F86	(YALIC) YALICCGN05	(YALIC) YALICCAT05	(YALIC) YALICSPA05		
Vestibule	F88	(YALIC) YALICCGN06	(YALIC) YALICCAT06	(YALIC) YALICSPA06		
Classroom / Intruder	F110	(YALIC) YALICCGN07	(YALIC) YALICCAT07	(YALIC) YALICSPA07		
Institution (keyed Dbl. cyl.)	F87	(YALIC) YALICCGN09	(YALIC) YALICCAT09	(YALIC) YALICSPA09		
Dormitory (Non-Clutch)	F90	(YALIC) YALICGN101	(YALIC) YALICAT101	(YALIC) YALICSPA101		

(SARIC) Indicates function available with Sargent Full Size Interchangeable Core. **6 PIN ONLY**
 (RUSIC) Indicates function available with Corbin / Russwin Full Size Interchangeable Core. **6 OR 7 PIN ONLY**
 (YALIC) Indicates function available with Yale Full Size Interchangeable Core. **6 PIN ONLY**

GENESYS Series

HEAVY DUTY CYLINDRICAL LEVERSETS WITH CLUTCH, ANSI - A156.2, SERIES 4000, GRADE 1

► **PACKAGING INCLUDES:**

- UL Listed 2 ¾" Backset, 2 ¼" x 1 ⅛" faceplate
- Standard "C", 6-pin cylinder
- ASA strike

► **For 2" up to 2 ¼" Thick Door Use Part # below**

CGN214T00 - Entrance, CGN00	CGN214T05 - Storeroom, CGN05
GN214T02 - Store Lock, GN02	CGN214T09 - Institution, CGN09
CGN214T03 - Classroom, CGN03	CGN214T20 - Privacy, CGN20
CGN214T04 - Communicating, CGN04	GN214T30 - Passage, GN30
⚙️ ICCGN214T00 - Entrance, ICCGN00	Available on AT, SPA & TUB Design. Use same Part No.
⚙️ ICCGN214T03 - Classroom, ICCGN03	
⚙️ ICCGN214T05 - Storeroom, ICCGN05	

► **KEYWAYS**

6-pin solid brass "C" keyway standard. Optional: Schlage E, Schlage C-K, Russwin D1-2-3-4, Corbin 59 / 60, Corbin-Russwin L4, Sargent LA-LB-LC, Falcon / Weiser E, Arrow A, Yale 8, Yale GA and Kwikset. Can also accept Medeco, Assa, Kaba and *Cal-Royal HSK* High Security Cylinders. See page L131 for keying charges and Cylinder PART #.

⚙️► **IC CORE, KEYING CHARGES**

For IC Core see pages L121-L122. For Keying see page L131.

► **TACTILE / LEAD LINING**

- Lead Lining Part # LEAD,
- Tactile Part # TAC,

► **MOUNT**

1 hole wooden mount
 Part # CGNMOUNT

► **ANTI MICROBIAL COATING**

- Available on US26D and US32D finishes.
- Specify "ANTB" when ordering.

GENESYS Series

ELECTRIFIED LOCKS

Available on Storeroom Only

FEATURES:

- UL Listed
- Continuous duty dual solenoids for cooler operation during "continuously ON" applications
- Low current draw
- 3 year "No Hassle" warranty

OPTIONS:

- Voltage requirement - 12-24V (DC)
- Amperage – 0.38A @ 12V or 0.19A @ 24V
- Power consumption - 4.6 watts
- Function – available Fail Safe, "Electrically Locked" (EL) or Fail Secure, "Electrically Unlocked" (EU)
- RX Switch option, use part # RXCGN.

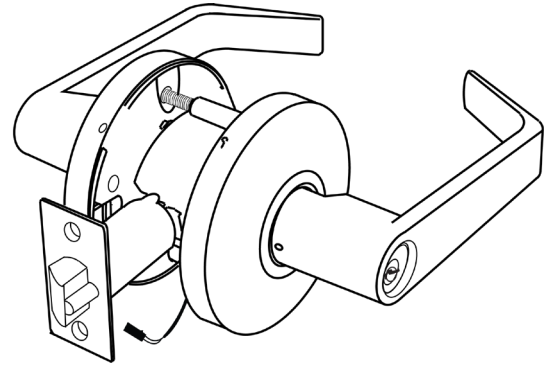

Available on all Genesys Series lever designs

HOW TO ORDER ELECTRIFIED

E - CGN05 - 1224 - EL - US26D

PREFIX "E" for Electrified
 LEVER DESIGN (CGN)
 LOCK FUNCTION (Storeroom)
 VOLTAGE REQUIREMENT (12-24V)
 FUNCTION (Fail Safe, Electrically Locked)
 FINISH (Satin Chrome)

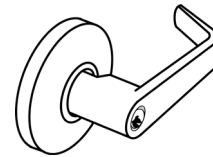

GN DESIGN

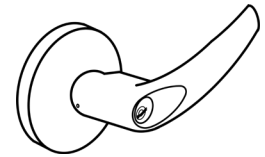

AT DESIGN

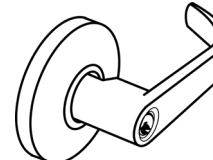

SPA DESIGN

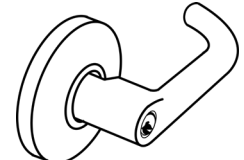

TUB DESIGN

TO ORDER:

- Prefix "E" before part #,
- Must specify the following when ordering:
 - lever design: CGN, CAT, CSPA, CTUB, CAUG, CDAN, CLON, or CTAC
 - lock function: "05" (Storeroom ONLY)
 - voltage: "1224" (12V/24V)
 - function: "EL" (fail safe) or "EU" (fail secure)
 - finish: see pages L32-L37 for stock finishes

Example: CGN05 US26D, 12-24V fail safe,

Order: "ECGN051224EL US26D"

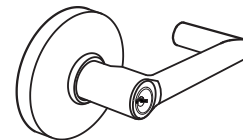

AUG DESIGN

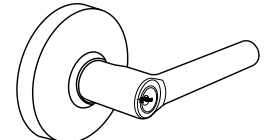

DAN DESIGN

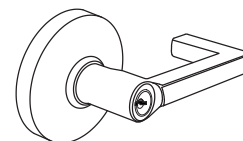

TAC DESIGN

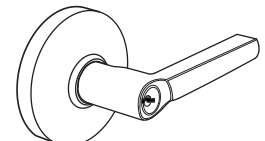



LON DESIGN

****CONSULT FACTORY FOR STOCK FINISHES AND AVAILABILITY**

- (IC) Indicates function available with Best, Falcon, and Arrow Interchangeable Core.
- (ICSC) Indicates function available with Schlage Full Size Interchangeable Core.
- (SARIC) Indicates function available with Sargent Full Size Interchangeable Core.
- (RUSIC) Indicates function available with Corbin / Russwin Full Size Interchangeable Core.
- (YALIC) Indicates function available with Yale Full Size Interchangeable Core. (**only available in GN, AT, SPA lever designs*)

► **ADDITIONAL PARTS & CHARGES FOR GENESYS SERIES**

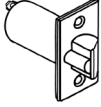
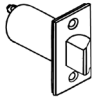
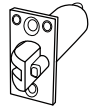
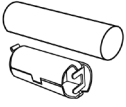
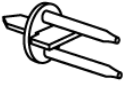
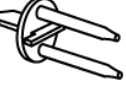
Backsets: UL listed 2 3/8", 2 1/4" x 1" Faceplate, **NO EXTRA CHARGE** if ordered with lock only.

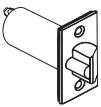
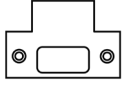
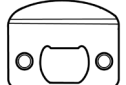
ILLUSTRATION	ITEM #	DESCRIPTION	FINISH
	GND238	CGN Series Dead Latch 2 3/8", 2 1/4" x 1" Faceplate	US3, 26D, 10B
	GNS238	CGN Series Spring Latch 2 3/8", 2 1/4" X 1" Faceplate	US3, 26D, 10B
	GND750	3/4" throw, Anti-Friction Dead Latch for pairs of fire doors, 2 1/4" x 1 1/8" Faceplate	US3, 26D, 10B, 10
	GEN5 EXT	5" Backset Extension Link	-----
	GEN334 EXT	3 3/4" Backset Extension Link	
TAIL PIECE			
	ICTP-01	6-pin Tail Piece for IC Genesys Series	-----
	ICTP-02	7 Pin Tail Piece for IC Genesys Series	
	ICTP-07	Tail Piece for Schlage Large Format IC Core	
EXTRA UL LISTED BACKSET			
	GND234	CGN Series 2 3/4" Dead latch, 2 1/4" x 1 1/8" Faceplate	US3, 26D, 10B
STRIKES			
	TS	T-Strike	US3, 26D, 10B, 26, 10, 4
	FLS	Full Lip Strike, Round Corner	