



**CAL-ROYAL**  
P R O D U C T S, I N C.



# EURO-DOOR HARDWARE PRICE LIST

2014 Version 1.0

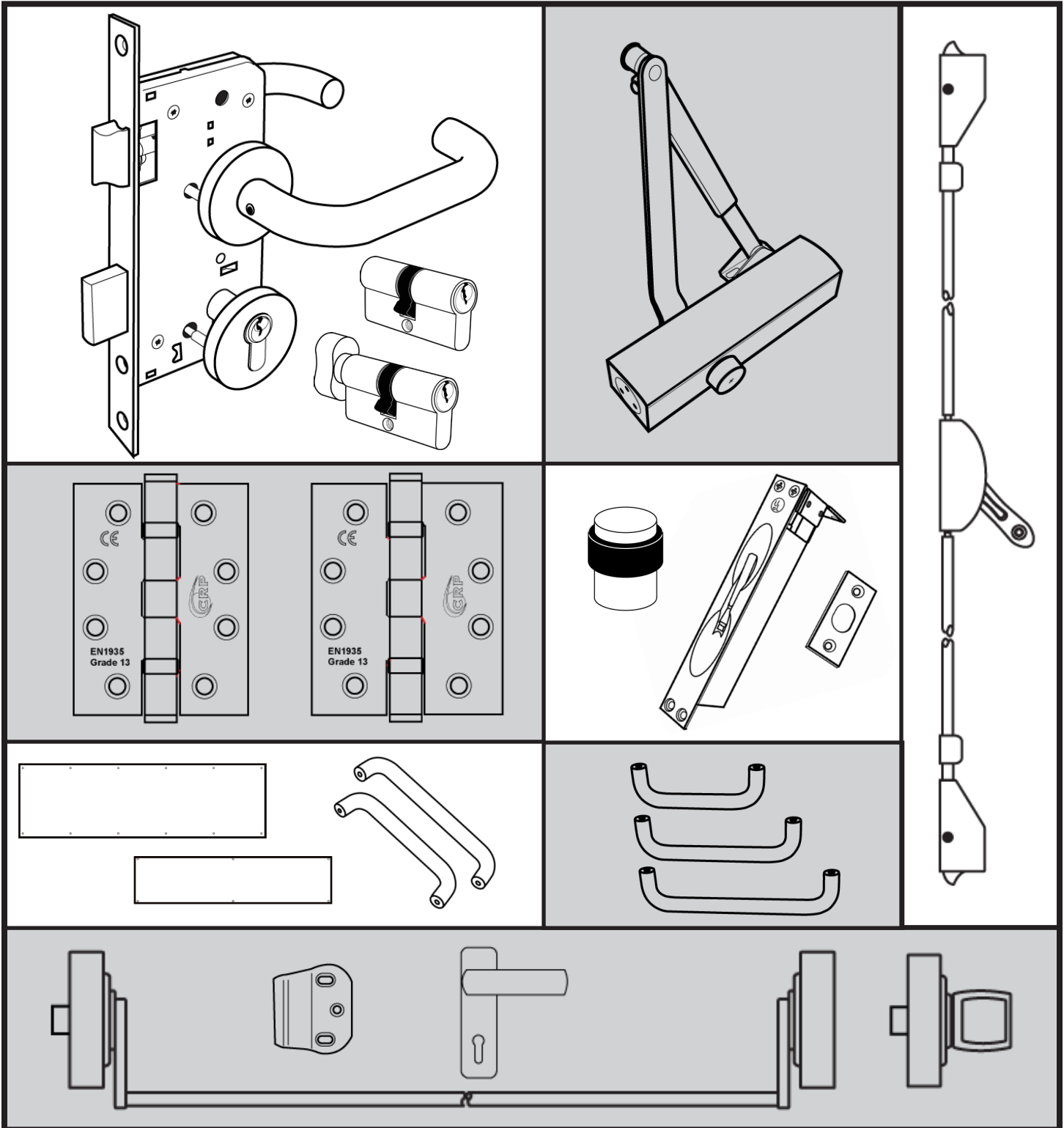



# EU 6400 SERIES MORTICE LOCKSET

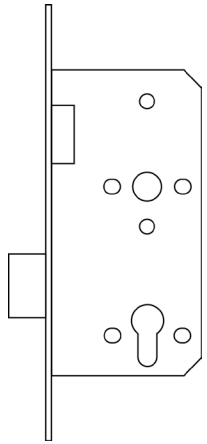

EU6410

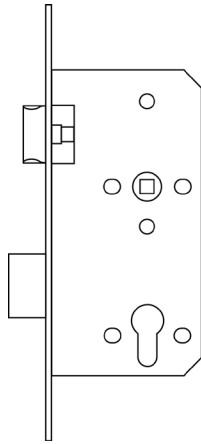

EU6420

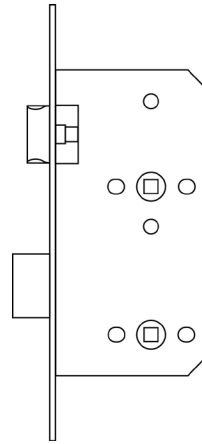

EU6430

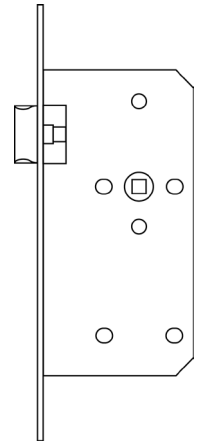

EU6440

ITEM#	DESCRIPTION	FINISH	UNIT	MC QTY	IP QTY	
EU6410	CYLINDER DEADLOCK	SATIN STAINLESS STEEL	For pricing & availability inquiries contact your Local Distributor or click <a href="#">here</a> for the list of our Sales Reps	EACH	30	1
EU6420	CYLINDER SASHLOCK			EACH	30	1
EU6430	BATHROOM LOCK			EACH	30	1
EU6440	PASSAGE LATCH			EACH	30	1

# EU 6400 SERIES LEVER TRIMS

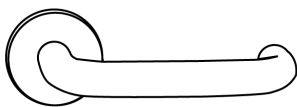

EU6450

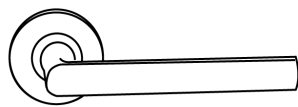

EU6451

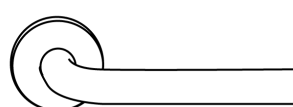

EU6452



EU6453

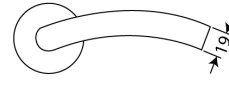
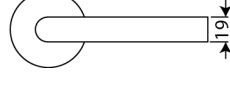
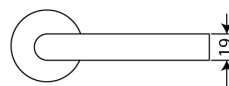
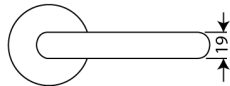
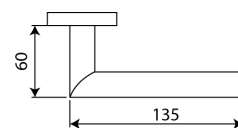
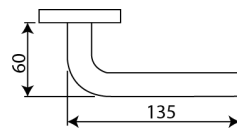
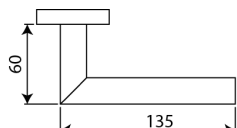
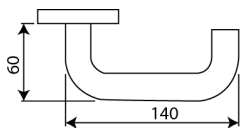

ITEM#	DESCRIPTION	FINISH	UNIT	MC QTY	IP QTY	
EU6450	"C" DESIGN TUBE LEVER	SATIN STAINLESS STEEL	For pricing & availability inquiries contact your Local Distributor or click <a href="#">here</a> for the list of our Sales Reps	EACH	20	1
EU6451	"L" DESIGN TUBE LEVER			EACH	20	1
EU6452	"J" DESIGN TUBE LEVER			EACH	20	1
EU6453	"ARCHED- L" DESIGN TUBE LEVER			EACH	20	1

# EU 6400 SERIES MORTICE LOCKSET CYLINDERS

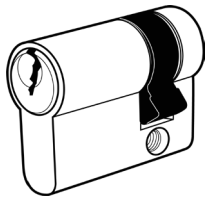

SINGLE CYLINDER

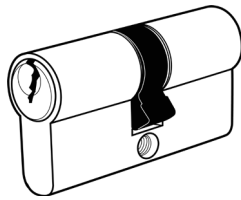

DOUBLE CYLINDER

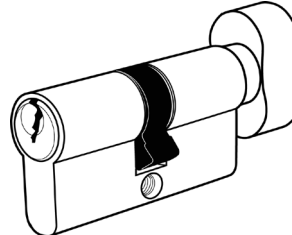

SINGLE CYLINDER  
WITH TURN

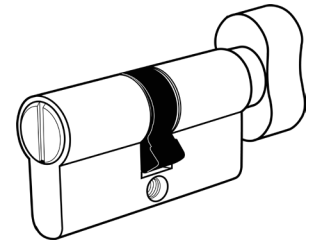

BATHROOM CYLINDER

ITEM CODE	KEYWAY	FUNCTION	LENGTH (mm)	FINISH	UNIT	MC QTY	IP QTY	
KE-YA8-S-A	Yale 8	Single Cylinder	45	SATIN NICKEL PLATED	For pricing & availability inquiries contact your Local Distributor or click <a href="#">here</a> for the list of our Sales Reps	EACH	50	1
KE-SCC-S-A	Schlage							
KE-YA8-D-C	Yale 8	Double Cylinder	60			EACH	50	1
KE-SCC-D-C	Schlage							
KE-YA8-D-D	Yale 8		70			EACH	50	1
KE-SCC-D-D	Schlage							
KE-YA8-C-C	Yale 8	Single Cylinder with Turn	60			EACH	50	1
KE-SCC-C-C	Schlage							
KE-YA8-C-D	Yale 8		70			EACH	50	1
KE-SCC-C-D	Schlage							
KE-P-C	-	Bathroom Cylinder	60	EACH	50	1		
KE-P-D	-		70	EACH	50	1		

# EU 6900 SERIES ESCUTCHEONS

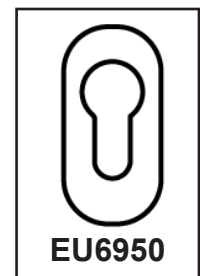
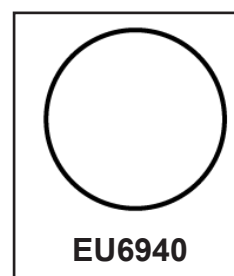
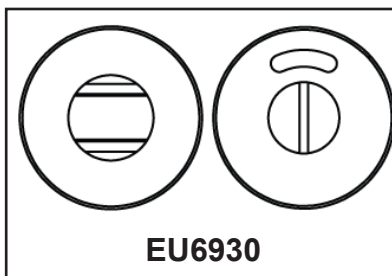
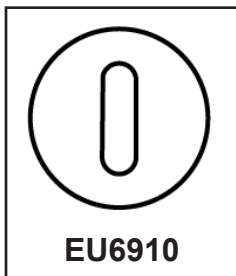

ITEM#	DESCRIPTION	FINISH	UNIT	MC QTY	IP QTY	
EU6910	Escutcheons (pair) - Lever key suitable for lock lever lock cases	SATIN STAINLESS STEEL	For pricing & availability inquiries contact your Local Distributor or click <a href="#">here</a> for the list of our Sales Reps	PAIR	100	10
EU6920	Escutcheons (pair) - Euro profile cylinder suitable for euro profile or dual profile cylinder lock cases			PAIR	100	10
EU6930	Bathroom turn and Indicator (set) - Supplied with 5mm bathroom function spindle Wide Turn			SET	50	5
EU6940	Escutcheons (pair) - Blank			PAIR	100	10
EU6950	Escutcheons (pair) - Oval profile cylinder suitable for oval profile or dual profile cylinder lock cases			PAIR	100	10

# EU 670 SERIES PUSH BAR PANIC EXIT HARDWARE

ITEM#	FUNCTION	DOOR WIDTH / HEIGHT	FINISH		UNIT	MC QTY	IP QTY	
EU670	Push Paddle Rim Emergency Device	Up to 1300mm wide	Aluminum	For pricing & availability inquiries contact your Local Distributor or click <a href="#">here</a> for the list of our Sales Reps	EACH	20	1	
			SSS					
EU672	Push Paddle Surface Vertical Rod Emergency Device	Up to 2500mm high x 1300mm wide	Aluminum		EACH	10	1	
			SSS					
EU677	Surface Vertical Rod Exit Device	Up to 2500mm high x 1300mm wide	Aluminum		EACH	6	1	
			SSS					
EU678	Rim Exit Device	Up to 1300mm wide	Aluminum		EACH	6	1	
			SSS					
OUTSIDE TRIM								
6413E/LE	Entrance Keyed Lever Trim	35mm to 65mm thick	Aluminum		For pricing & availability inquiries contact your Local Distributor or click <a href="#">here</a> for the list of our Sales Reps	EACH	20	1
			SSS					
6414/LE	Passage Non-Keyed Lever Trim	35mm to 65mm thick	Aluminum	EACH	20	1		
			SSS					
ACCESSORIES								
67-XLVR	Extra Long Vertical Rod for 3048mm doors		Aluminum	For pricing & availability inquiries contact your Local Distributor or click <a href="#">here</a> for the list of our Sales Reps	EACH	20	1	
67-DSTPL	Double Door Overlapping Strike Plate		Aluminum		EACH	50	1	
			SSS					

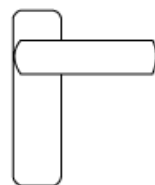

6414/LE

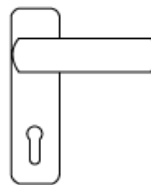

6413E/LE

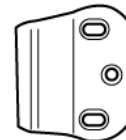

67-DSTPL

# EU DOOR CLOSERS AND FLOOR HINGES

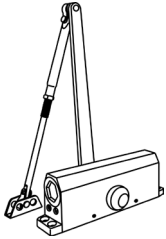

EU430

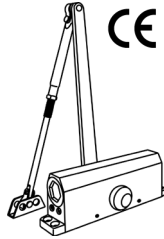

EU430CE

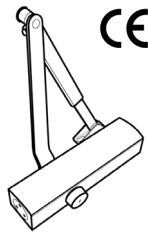

EU530



EU530COV

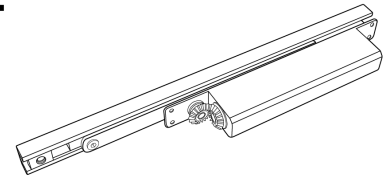

EU8320

ITEM#	DESCRIPTION	SIZE	FINISH	UNIT	MC QTY	IP QTY
EU430	Power adjustable by position during installation to suit closer sizes #2 to #4. It does not have the CE Mark and is designed for use in non-fire door applications only. Door Closer	#2 TO #4 by Position	Aluminum	Each	10	1
EU430CE	Tested to EN 1154 483113 and CE Marked EN 1634 for up to 2 hour timber fire door Certifire Approved CF390 EN Door Closer	#3 Fixed	Aluminum	Each	10	1
PAEU430	Parallel Arm Bracket for EU430 and EU430CE	---	Aluminum	Each	100	10
EU530	Tested to EN 1154 48113 and CE Marked by Warrington APT Laboratories, UK EN 1634 Fire Tested Door Closer no cover	#2 TO #4 by Position	Aluminum	Each	10	1
EU530	Tested to EN 1154 48113 and CE Marked by Warrington APT Laboratories, UK EN 1634 Fire Tested Door Closer with <b>Stainless Steel FULL COVER</b>	#2 TO #4 by Position	Satin Stainles Steel	Each	10	1
PAEU530	Parallel Arm Bracket for EU530		Aluminum	Each	100	10
530COV	Plated metal full cover for EU530		Satin Stainles Steel	Each	20	1
EU8320	Concealed Door Closer Tested to EN 1154 483113, CE Marked EN 1634 Fire Tested by Warrington APT Laboratories, UK	#2 TO #4 by Spring #3 Preset (CE)	Aluminum	Each	10	1
EU8844	Floor Hinges Tested to EN 1154 383113 384113 by Warrington APT Laboratories UK Power #4 ≤1100mm ≤150kg EN 1634 Fire Tested	#4 Fixed 90° Hold-Open	Satin Stainles Steel	Each	4	1
EU8844NHO		#4 Fixed NO Hold-Open				
EU8844HO105		#4 Fixed 105° Hold-Open				
OP8840LH	Offset Pivot for 8840 Series Floor Hinges (Left Hand)			Set	10	1
OP8840RH	Offset Pivot for 8840 Series Floor Hinges (Right Hand)			Set	10	1
NSA8840	Standard Strap, Top and Bottom Pivot			Set	10	1

For pricing & availability inquiries contact your Local Distributor or click [here](#) for the list of our Sales Reps



EU8840

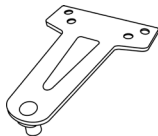

PARALLEL ARM BRACKET

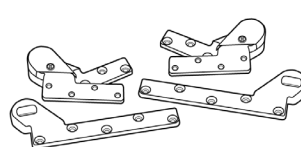

OP8840

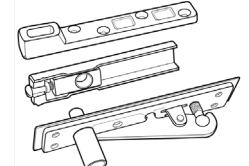

NSA8840

# EU 6800 SERIES HINGES

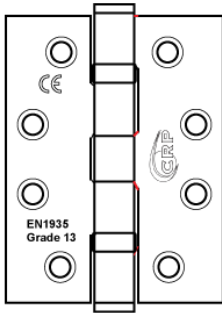

BB6801

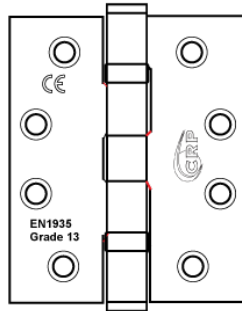

BB6802

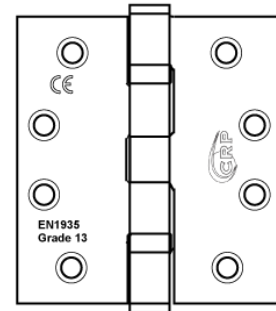

BB6803

ITEM#	SIZE (mm)	FINISH	UNIT	MC QTY	IP QTY
BB6801	101,6 X 76,2 X 3	SATIN STAINLESS STEEL	EACH	60	2
BB6802	101,6 X 89 X 3	SATIN STAINLESS STEEL	EACH	60	2
BB6803	101,6 X 101,6 X 3	SATIN STAINLESS STEEL	EACH	60	2

For pricing & availability inquiries contact your Local Distributor or click [here](#) for the list of our Sales Reps

## BUILDERS HARDWARE

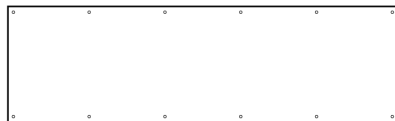

BKICK834, BKICK1034, BKICK1046



PSPL3515, PSPL4116

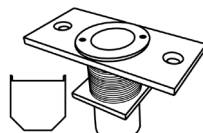

DPSTRK1

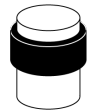

EUS03

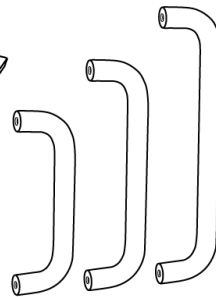

PUL204 PUL203 PUL202

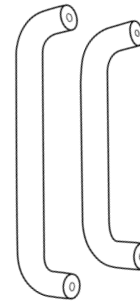

PUL200 PUL201

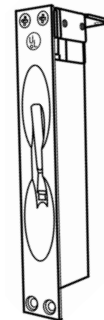

WFUL634



ULFB634

ITEM#	DESCRIPTION	FINISH	UNIT	MC QTY	IP QTY
ULFB634	Solid Brass Commercial Manual Flush Bolt	SCP	EACH	50	2
WFUL634	Solid Brass Commercial Wood Lever Extension Flush Bolt	SCP	EACH	50	1
DPSTRK1	Brass Dustproof Strike	SCP	EACH	100	10
EUS03	Floor Mount Door Stop	SSS	EACH	100	10
PUL202	Solid Bar Round Pulls 19,05mm Diameter. 254mm ctc	SSS	EACH	10	1
PUL203	Solid Bar Round Pulls 19,05mm Diameter. 203,2mm ctc	SSS	EACH	10	1
PUL204	Solid Bar Round Pulls 19,05mm Diameter. 152,4mm ctc	SSS	EACH	10	1
PUL200	Solid Bar Round Pulls 25,4mm Diameter. 254 ctc	SSS	EACH	20	1
PUL201	Solid Bar Round Pulls 25,4mm Diameter. 203,2 ctc	SSS	EACH	20	1
PSPL3515	Push Plate, 381mm W x 88,9 mm H	SSS	EACH	60	1
PSPL4016	Push Plate, 406,4mm W x 101,6mm H	SSS	EACH	60	1
BKICK834	Metal Kick Plate. 863,6mm W x 203,2 mm H	SSS	EACH	10	1
BKICK1034	Metal Kick Plate. 863,6mm W x 254mm H	SSS	EACH	10	1
BKICK1046	Metal Kick Plate. 1168,4mm W x 254mm H	SSS	EACH	8	1

For pricing & availability inquiries contact your Local Distributor or click [here](#) for the list of our Sales Reps

# DOOR HARDWARE PROTECTION KITS

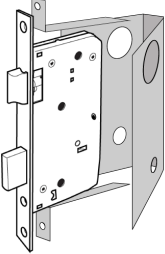
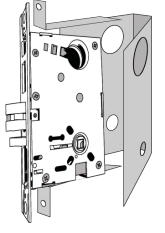
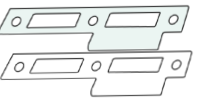
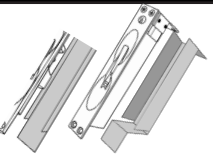
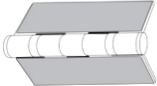
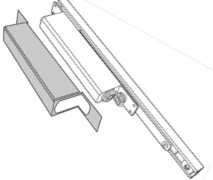
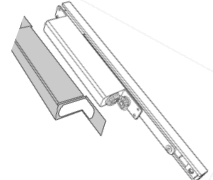
ITEM#	PROFILE	DESCRIPTION	FINISH	UOM
<b>MORTICE LOCK CASES</b>				
		<b>LOCK KITS - 30 &amp; 60 MIN FIRE RATING WITH SELF-ADHESIVE TAPE BACK</b>		
ITLE-160X90-1MM		Lock Kit to suit standard DIN upright Mortice lock case To suit 55mm/60mm backset and 72 centres Supplied as 1 part kit around lock body w/ S/A tape for easy installation	WHITE	For pricing & availability inquiries contact your Local Distributor or click <a href="#">here</a> for the list of our Sales Reps
ITLE-160X90-2MM		<b>LOCK KITS - 90 &amp; 120 MIN FIRE RATING WITH SELF-ADHESIVE TAPE BACK</b>	Lock Kit to suit standard DIN upright Mortice lock case To suit 55mm/60mm backset and 72 centres Supplied as 1 part kit around lock body w/ S/A tape for easy installation	WHITE
<b>ANSI MORTICE LOCK CASES</b>				
ITLA-160X90-1MM		<b>ANSI LOCK KITS - 30 &amp; 60 MIN FIRE RATING WITH SELF-ADHESIVE TAPE BACK</b>	WHITE	For pricing & availability inquiries contact your Local Distributor or click <a href="#">here</a> for the list of our Sales Reps
		Lock Kit to suit standard DIN upright Mortice lock case Supplied as 1 part kit around lock body w/ S/A tape for easy installation		
ITLA-160X90-2MM		<b>ANSI LOCK KITS - 60 &amp; 120 MIN FIRE RATING WITH SELF-ADHESIVE TAPE BACK</b>	WHITE	Per Lock
		Lock Kit to suit standard DIN upright Mortice lock case Supplied as 1 part kit around lock body w/ S/A tape for easy installation		
<b>STRIKE PLATE KITS</b>				
ITSP-160X90-1MM		Strike plate kit to suit standard ANSI Mortice lock case Supplied as 1 part kit around lock body w/ S/A tape for easy installation	WHITE	For pricing & availability inquiries contact your Local Distributor or click <a href="#">here</a> for the list of our Sales Reps
ITSP-160X90-2MM		Strike plate kit to suit standard ANSI Mortice lock case Supplied as 1 part kit around lock body w/ S/A tape for easy installation	WHITE	Per Lock
<b>FLUSH BOLT KITS</b>				
ITFL-160X90-1MM ITWFL-160X90-1MM		Flush Bolt Kit to suit 200 x 19mm Flush Bolt Supplied as 1 part kit around lock body w/ S/A tape for easy installation	WHITE	For pricing & availability inquiries contact your Local Distributor or click <a href="#">here</a> for the list of our Sales Reps
ITFL-160X90-2MM ITWFL-160X90-2MM		Flush Bolt Kit to suit 200 x 19mm Flush Bolt Supplied as 1 part kit around lock body w/ S/A tape for easy installation	WHITE	Per FB
<b>HINGE KITS - 90 &amp; 120 MIN FIRE RATING WITH SELF-ADHESIVE TAPE BACK</b>				
ITH-102X76-2MM		Hinge Kit to suit 102 x 76mm (Supplied as 2 pcs of 100 x 30mm)	WHITE	For pricing & availability inquiries contact your Local Distributor or click <a href="#">here</a> for the list of our Sales Reps
ITH-102X89-2MM		Hinge Kit to suit 102 x 89mm (Supplied as 2 pcs of 100 x 36mm)	WHITE	Per Hinge
ITH-102X102-2MM		Hinge Kit to suit 102 x 102mm (Supplied as 2 pcs of 100 x 42mm)	WHITE	Per Hinge
<b>DOOR CLOSER KITS</b>				
<b>DOOR CLOSER KITS - TO SUIT POWER SIZE 1 - 3</b>				
ITDC-SZ123-FD3060		Door Closer Kit FD30 - 1mm thick 2-Part Kit: 1mm around Door Closer Body and 1mm around Top Channel with S/A tape	WHITE	For pricing & availability inquiries contact your Local Distributor or click <a href="#">here</a> for the list of our Sales Reps
ITDC-SZ123-FD90		Door Closer Kit FD60 - 2mm thick 2-Part Kit: 2mm around Door Closer Body and 2mm around Top Channel with S/A tape	WHITE	Per Closer
<b>DOOR CLOSER KITS - TO SUIT POWER SIZE 3 - 5</b>				
ITDC-SZ225-FD3060		Door Closer Kit FD60 - 1mm thick 2-Part Kit: 1mm around Door Closer Body and 1mm around Top Channel with S/A tape	WHITE	For pricing & availability inquiries contact your Local Distributor or click <a href="#">here</a> for the list of our Sales Reps
ITDC-SZ225-FD90		Door Closer Kit FD90 - 2mm thick 2-Part Kit: 2mm around Door Closer Body and 2mm around Top Channel with S/A tape	WHITE	Per Closer