

OMEGA

QUALITY DESIGNED AND ENGINEERED
FOR COMMERCIAL BUILDINGS
OPTIONAL THRU BOLT INSTALLATION



MEETS
The Buy American Act

Conforms with
BHMA/ANSI A156.2
Series 4000, Grade 1
Exceeds 1,000,000 cycles

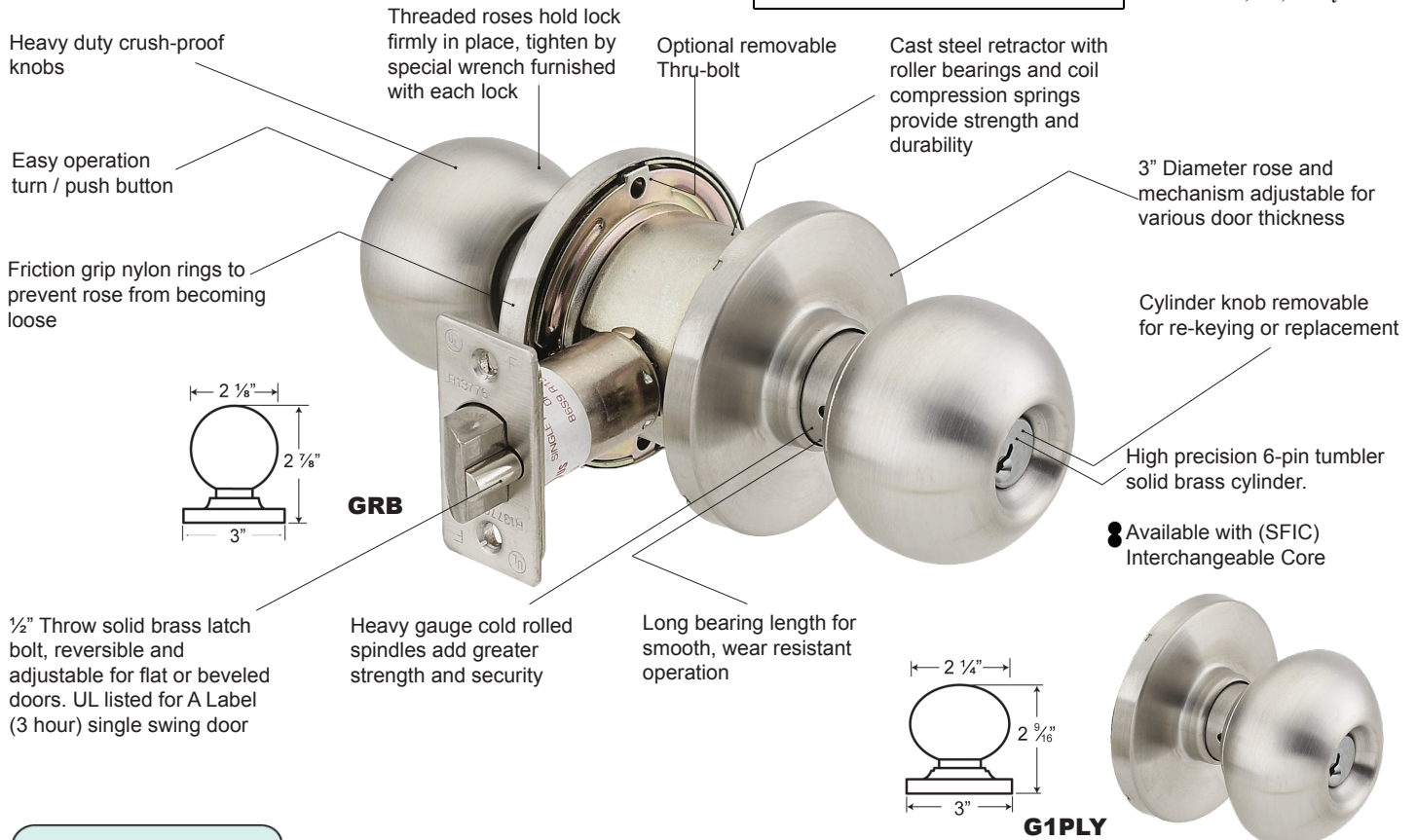

SPECIFICATIONS

DOOR RANGES

Adjustable 1 3/8" to 2" door thickness.

BACKSET

2 3/4" Standard, 2 5/8", 3 3/4", 5" and 2 3/4" anti-friction latch with 3/4" throw for pair of fire doors optional.

LATCH FACEPLATE

Standard 2 1/4" x 1 1/8" for 2 3/4" backset.
Optional 2 1/4" x 1 1/8" for 2 5/8" backset.

STRIKES

ASA strike standard, 4 7/8" x 1 1/4". Optional "T" and full lip strike available on request.

KEYWAY

6-pin "C" keyway cylinder, 2 keys per lock.

BORE DIAMETER

1" for latch. 2 1/8" for lock housing.

HANDING

Completely reversible.

ADDITIONAL KEYWAYS

6 pin solid brass "C" keyway standard. Schlage E, Schlage C-K, Russwin D1-2-3-4, Corbin 59 / 60, Corbin-Russwin L4, Sargent LA-LB-LC, Falcon / Weiser E, Arrow A, Yale 8, Yale GA and Kwikset. Can also accept Medeco, Assa, Kaba and Cal-Royal (HSK) High Security Cylinders.

ELECTRIFIED LOCKS, TACTILE & LEAD LINING

Available upon request.

INTERCHANGEABLE CORE

Interchangeable Core locks will accept compatible 6 or 7 pin cores with BEST, FALCON and ARROW. Prefix "IC" before part number. Available combined or uncombined. Temporary construction cores available. Factory keying with control key and master key available.

EXPOSED TRIM

Wrought brass, bronze or stainless steel.

ANSI STANDARDS

Meets or exceeds requirements of BHMA / ANSI A156.2 Series 4000 for Grade 1 (FF-H-106C)

OMEGA GRB SERIES FINISHES AND FUNCTIONS



FINISHES AVAILABLE		
BHMA SYMBOL	US CODE	DESCRIPTION
605	US3	Polished Brass
606	US4	Satin Brass
609	US5	Antique Brass
612	US10	Satin Bronze
613	US10B	Oil Rubbed Bronze
619	US15	Satin Nickel
625	US26	Polished Chrome
626	US26D	Satin Chrome
630	US32D	Satin Stainless Steel

DOOR PREPARATION

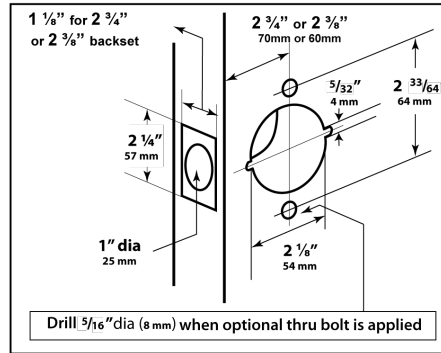

Refer to price list for stock finishes and functions

GRB00
ICGRB00
ANSI F109  **ENTRANCE / OFFICE LOCK**
 Turn / Push button locking. Pushing and turning button locks outside knob requiring use of key until button is manually unlocked. Pushing button locks outside knob until unlocked with key or inside knob is turned.

GRB09
ICGRB09
ANSI F87  **INSTITUTION**
 Deadlocking latch bolt operated by key in knob from either side. Both knobs are always fixed.

GRB01
ICGRB01
ANSI F82  **ENTRANCE / PUSH BUTTON LOCK**
 Pushing button in inside knob locks outside knob. Turning inside knob or operating key in outside knob releases button automatically. Closing door does not release button. Button cannot be fixed in lock position. Inside knob always free. Latch bolt automatically deadlocks when door is closed.

GRB80
ICGRB80  **EXIT LOCK / CONNECTING ROOM**
 Deadlocking latch bolt operated with key from inside only. Blank plate outside.

GRB02
ICGRB02
ANSI F91  **STORELOCK**
 Deadlocking latch bolt operated by knob from either side, except when both knobs are locked by key in knob from either side.

GRB10
ANSI F77  **PATIO LOCK**
 Deadlocking latch bolt operated by knob from either side. Outside knob is locked by push button inside and unlocked by rotating inside knob or closing door.

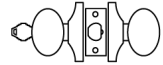
GRB03
ICGRB03
ANSI F84  **CLASSROOM**
 Deadlocking latch bolt operated by knob from either side except when outside knob is locked from outside by key. When outside knob is locked, latch bolt is operated by turning inside knob.

GRB20
ANSI F76  **PRIVACY LOCK**
 Latch bolt operated by knob from either side. Outside knob is locked by push button inside and unlocked by emergency release outside. Turning inside knob or closing door releases push button.

GRB04
ICGRB04
ANSI F80  **COMMUNICATING**
 Deadlocking latch bolt operated by knob from either side. Turning key in either knob locks or unlocks its own knob independently.

GRB30
ANSI F75  **PASSAGE SET**
 Latch bolt operated by knob from either side at all times.

GRB05
ICGRB05
ANSI F86  **STOREROOM**
 Deadlocking latch bolt operated by key in outside knob or by rotating inside knob. Outside knob is always fixed.

GRB40  **DUMMY LEVER**
 Single dummy trim for one side of door. Pull only.

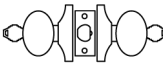
GRB06
ICGRB06
ANSI F88  **VESTIBULE**
 Deadlocking latch bolt operated by knob from either side except when outside knob is locked by key from inside. Latch bolt may be retracted by key in outside knob or by rotating inside knob.

GRB50
ANSI F89  **EXIT LOCK**
 Deadlocking latch bolt by inside knob. Outside plate only.

“IC” Indicates function available with BEST, FALCON & ARROW Interchangeable Core.

**HOW TO ORDER: For “G1PLY” Designs, replace design name.
 Example: GRB00 entrance in “G1PLY” is G1PLY00.**

OTHER FUNCTIONS NOT LISTED AVAILABLE UPON REQUEST