







Replacement Cylinders

Features:

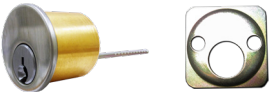
- Made to Original Manufacturers' Keying Specifications
- Can be keyed with original pins
- All Cylinders drilled for 6-Pins
- Packed with appropriate accessories

KEY-IN-KNOB / LEVER & DEADBOLT CYLINDER (Packed with tailpiece assortment pack)				
ILLUSTRATION	ITEM#	DESCRIPTION	KEYED	FINISH
	KKARA-4	6-Pin Arrow "A"	5-Pin	US26D
	KKC59-4	6-Pin Corbin 60 Russwin 59	5-Pin	
	KKCL4-4	6-Pin Corbin L1 thru L4	6-Pin	
	KKKW5-4	6-Pin Kwikset	5-Pin	
	KKR-D1-4	6-Pin Russwin D-1 thru 4	6-Pin	
	KKSCC-4	6-Pin Schlage "C"	6-Pin	
	KKSCE-4	6-Pin Schlage "E"	6-Pin	
	KKSCF-4	6-Pin Schlage "F"	6-Pin	
	KKSCP-4	6-Pin Schlage C-K	5-Pin	
	KKSLA-4	6-Pin Sargent "LA" thru "LC"	6-Pin	
	KKSRA-4	6-Pin Sargent "RA"	6-Pin	
	KKWFE-4	6-Pin Weiser / Falcon "E"	5-Pin	
	KKYA8-4	6-Pin Yale 8 (E1R)	5-Pin	
	KKYGA-4	6-Pin Yale "GA"	6-Pin	
1-1/4" MORTISE CYLINDERS (Packed with Adams Rite and Yale Cams)				
	KMARA-4	6-Pin Arrow "A"	5-Pin	US26D
	KMC59-4	6-Pin Corbin 60 Russwin 59	5-Pin	
	KMCL4-4	6-Pin Corbin L1 thru L4	6-Pin	
	KMKW5-4	6-Pin Kwikset	5-Pin	
	KMRD1-4	6-Pin Russwin D-1 thru 4	6-Pin	
	KMSCC-4	6-Pin Schlage "C"	6-Pin	
	KMSCE-4	6-Pin Schlage "E"	6-Pin	
	KMSCF-4	6-Pin Schlage "F"	6-Pin	
	KMSCP-4	6-Pin Schlage C-K	5-Pin	
	KMSLA-4	6-Pin Sargent "LA" thru "LC"	6-Pin	
	KMSRA-4	6-Pin Sargent "RA"	6-Pin	
	KMWFE-4	6-Pin Weiser / Falcon "E"	5-Pin	
	KMYA8-4	6-Pin Yale 8 (E1R)	5-Pin	
	KMYGA-4	6-Pin Yale "GA"	6-Pin	
RIM CYLINDERS				
	KR-AR-A	Arrow "A"	5-Pin	US26D
	KR-C-59	Corbin 60 Russwin 59	5-Pin	
	KR-C-L4	Corbin L1 thru L4	6-Pin	
	KR-KW-5	Kwikset	5-Pin	
	KR-R-D1	Russwin D-1 thru 4	6-Pin	
	KR-SC-C	Schlage "C"	6-Pin	
	KR-SC-E	Schlage "E"	6-Pin	
	KR-SC-F	Schlage "F"	6-Pin	
	KR-SC-P	Schlage C-K	5-Pin	
	KR-S-LA	Sargent "LA" thru "LC"	6-Pin	
	KR-S-RA	Sargent "RA"	6-Pin	
	KR-WF-E	Weiser / Falcon "E"	5-Pin	
	KR-YA-8	Yale 8 (E1R)	5-Pin	
	KR-Y-GA	Yale "GA"	6-Pin	

6 PIN SCHLAGE "C" KEYWAY MORTISE AND RIM CYLINDERS

ILLUSTRATION	ITEM NO	DESCRIPTION	FINISH
	CX96RIM	6-Pin SCHLAGE "C" keyway 1 1/8" Rim Cylinder with mounting plate & screws	US26D, US10B, 3
	AMORTCYL118	6-Pin SCHLAGE "C" Keyway Mortise Cylinder 1 1/8" length, with Adams Rite Cam	
	AMORTCYL114	6-Pin SCHLAGE "C" Keyway Mortise Cylinder 1 1/4" length, with Adams Rite Cam	
	CMORTCYL118	6-Pin SCHLAGE "C" Keyway Mortise Cylinder 1 1/8" length, with CLOVER LEAF cam	
	CMORTCYL114	6-Pin SCHLAGE "C" Keyway Mortise Cylinder 1 1/4" length, with CLOVER LEAF cam	
	THMBMORT100	1" Mortise Cylinder with Thumbturn	
	BLNKMORT100	1" Blank Mortise Cylinder	

6 PIN SCHLAGE "C" KEYWAY EUROPEAN PROFILE MORTISE CYLINDERS

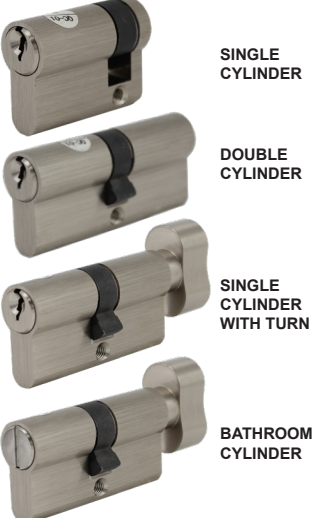
 <p>SINGLE CYLINDER</p> <p>DOUBLE CYLINDER</p> <p>SINGLE CYLINDER WITH TURN</p> <p>BATHROOM CYLINDER</p>	KE-SCC-S-A	Single Cylinder 45mm Schlage "C", 6-pin rekeyable	US15
	KE-SCC-D-C	Double Cylinder 60mm Schlage "C", 6-pin rekeyable	
	KE-SCC-D-D	Double Cylinder 70mm Schlage "C", 6-pin rekeyable	
	KE-SCC-C-C	Single Cylinder with turn 60mm Schlage "C", 6-pin rekeyable	
	KE-SCC-C-D	Single Cylinder with turn 70mm Schlage "C", 6-pin rekeyable	
	KE-P-C	Bathroom Cylinder 60mm	
	KE-P-D	Bathroom Cylinder 70mm	

MORTISE CYLINDER ACCESSORIES

 <p>CGR175</p> <p>MCRC-250</p>	MCCR1814	Mortise Cylinder Compression Ring 1/8" to 1/4"	US26D, US10B, 3
	MCCR3812	Mortise Cylinder Compression Ring 3/8" to 1/2"	
	CGR175	Cylinder Guard Ring 1 3/4" base and 1/2" projection with Wave Washer and Spacing Collar	US26D, US10B, US3, 4
	MCRC-250	Free-Spinning Cylinder Guard Ring 1/4"	US3, 15, US26D, US10B

STANDARD MORTISE CAMS

												
KC-C1	KC-C3	KC-C4	KC-C5	KC-C8	KC-C9	KC-S1	KC-S3	KC-S4	KC-S5	KC-S6	KC-S7	KC-S9
ADAMS RITE	YALE	RUSSWIN	NM SERIES	SCHLAGE L	SARGENT	ADAMS RITE	YALE MORTISE	RUSSWIN	FALCON	CRP PANIC TRIM	SC SERIES	SARGENT

Best / Falcon 6 & 7 Pin Small Format Interchangeable Cores and Key Blanks (SFIC) Key Sections (A, B, C, D, E, F, G, H, J, K, L, M, Q, TB)

*All above Keyways in stock for immediate shipment

Features:



- Operates on Best / Falcon small format interchangeable cores locksets, deadbolts, rim and mortise cylinders
 - Operates on all of Cal-Royal's keyed locksets prepared for small format
- Best/ Falcon A, B, C, D, E, F, G, H, J, K, L, M, Q, TB Keyways**

BEST / FALCON 6 & 7 PIN SMALL FORMAT INTERCHANGEABLE CORES & KEY BLANK					
ILLUSTRATION	KEY SECTIONS	UNCOMBINATED	MASTER KEYED	KEY BLANKS	FINISH
6 PIN MASTER KEYED 6 PIN UNCOMBINATED 7 PIN MASTER KEYED 7 PIN UNCOMBINATED 		*6PUC A (6-Pins)	6PCCA-MK (6-Pins)	KBSF-A	US26D, US4
		*7PUC A (7-Pins)	7PCC A-MK (7-Pins)	KBSF-A	
		7PUC B (7-Pins)	7PCC B-MK (7-Pins)	KBSF-B	
		7PUC C (7-Pins)	7PCC C-MK (7-Pins)	KBSF-C	
		7PUC D (7-Pins)	7PCC D-MK (7-Pins)	KBSF-D	
		7PUC E (7-Pins)	7PCC E-MK (7-Pins)	KBSF-E	
		7PUC F (7-Pins)	7PCC F-MK (7-Pins)	KBSF-F	
		7PUC G (7-Pins)	7PCC G-MK (7-Pins)	KBSF-G	
		7PUC H (7-Pins)	7PCC H-MK (7-Pins)	KBSF-H	
		7PUC J (7-Pins)	7PCC J-MK (7-Pins)	KBSF-J	
		7PUC K (7-Pins)	7PCC K-MK (7-Pins)	KBSF-K	
		7PUC L (7-Pins)	7PCC L-MK (7-Pins)	KBSF-L	
7PUC M (7-Pins)		7PCC M-MK (7-Pins)	KBSF-M		
7PUC Q (7-Pins)		7PCC Q-MK (7-Pins)	KBSF-Q		
		7PUC TB (7-Pins)	7PCC TB-MK (7-Pins)	KBSF-TB	
ICPTT	6PCC-KD	Best, Falcon and Arrow Small Format. 6-Pin Interchangeable Core, Rim and Mortise Cylinder.		US26D, US4	
	7PCC-KD	Best, Falcon and Arrow Small Format. 7-Pin Interchangeable Core, Rim and Mortise Cylinder.			
	ICCC	Temporary 6-Pin construction cores			
	ICCC7	Temporary 7-Pin construction cores			
	ICPTT	Plastic thumbturns available for non-secured areas			YELLOW
BEST, FALCON AND ARROW 6 / 7 PIN SMALL FORMAT INTERCHANGEABLE CORE MORTISE AND RIM CYLINDER					
	308-602	Best, Falcon and Arrow 6 / 7-Pin Small Format Interchangeable Core Rim Cylinder with mounting plate & screws			US26D, US10B, US3
	307-601	Best, Falcon and Arrow 6 / 7-Pin Small Format Interchangeable Core Mortise Cylinder with Adams Rite Cam, 1 1/4" length			
	ICH961387	Best, Falcon and Arrow 6 / 7-Pin Small Format Interchangeable Core Mortise Cylinder, Cloverleaf Cam 1 1/4" length, To be used with Cal-Royal NM Series Mortise locks			

Large Format 6 Pin Interchangeable Core and Housing (LFIC)

Features:

- Operates on all Schlage, Sargent LA-LB-LC, Russwin D1-D2-D3-D4, Yale GA large format interchangeable cores locksets, deadbolts, rim and mortise cylinders.

LARGE FORMAT 6 PIN INTERCHANGEABLE CORE CYLINDERS			
ILLUSTRATION	ITEM#	DESCRIPTION	FINISH
 <p>KL-LAD-SA</p> <p>KL-RD1-CR</p> <p>KL-YGA-YA</p>	3000 ICC	6-Pin "C" keyway combined SCHLAGE large format IC core cylinder KA# 111111 with "C" key blanks	US26D, 4
	4000ICCK	6-Pin "C-K" keyway combined SCHLAGE large format IC core cylinder KA# 111111 with "E" key blanks	
	5000ICE	6-Pin "E" keyway combined SCHLAGE large format IC core cylinder KA# 111111 with "E" key blanks	
	1000ICC	6-Pin "C" keyway combined SCHLAGE large format IC core cylinder KD and MK	
	2000 ICC	Temporary 6-Pin Construction Cores (Keyed Alike) will be charged on a separate memo billing for 6 months. On return to the factory credit will be issued.	
	KL-LAD-SA	SARGENT LA-LB-LC LFIC 6-Pin Uncombined	
	KL-RD1-CR	RUSSWIN / CORBIN D1-D2-D3-D4 LFIC 6-Pin Uncombined	
	KL-YGA-YA	YALE GA LFIC 6-Pin Uncombined	
LARGE FORMAT 6 PIN INTERCHANGEABLE CORE MORTISE AND RIM CYLINDER HOUSING			
	6000ICMA	SCHLAGE Large format Interchangeable Core Mortise cylinder housing with Adams Rite Cam 1 1/2" long	US26D, US10B, 3
	7000ICMC	SCHLAGE Large format Interchangeable Core Mortise cylinder housing with Cloverleaf Cam 1 1/2" long. To be used with Cal-Royal NM Series Mortise locks. Can also be used with Cal-Royal SC Series Mortise locks (with CAMSCHL-7 Schlage Cam).	
	8000 ICRIM	SCHLAGE Large format Interchangeable Core rim cylinder housing with mounting plate and screw	
	KM-LFH-SA	SARGENT Large format Interchangeable Core Mortise cylinder housing with Adams Rite Cam 1 1/2" long. Optional rim pack, 26D only (See Price Book page L122)	
	KM-LFH-CR	CORBIN/RUSSWIN Large format Interchangeable Core Mortise cylinder housing with Adams Rite Cam 1 1/2" long. Optional rim pack, 26D only (See Price Book page L122)	
	KM-LFH-YA	YALE Large format Interchangeable Core Mortise cylinder housing with Adams Rite Cam 1 1/2" long. Optional rim pack, 26D only (See Price Book page L122)	

RESTRICTED KEY CONTROL USING CONVENTIONAL REPLACEMENT CYLINDERS (TIER 3)

Tier 3 Conventional Replacement Cylinders

Provide restricted key control by utilizing the HSK **Patented** key system, without the cost of anti pick drill and bump features. Tier 3 cylinders can be incorporated into HSK Tier 1 & 2 Master Key and Key systems. HSK Tier 1 & 2 keys will work in Tier 3 cylinders however Tier 3 keys will not work in Tier 1 & 2 HSK Cylinders. Tier 3 keys are covered under our patented key system.

Tier 2 High Security Cylinders

Have anti-pick, anti-drill and anti-bump features without the UL 437 Certification. See HSK Section.

Tier 1 (UL 437) High Security Cylinders

Have anti pick, anti drill and anti bump features incorporated and have the UL 437 Certification. See HSK Section.





RESTRICTED KEY CONTROL REPLACEMENT CYLINDERS		
KEY-IN-KNOB-LEVER CYLINDERS	SMALL FORMAT IC CYLINDERS	MORTISE CYLINDERS
		
<p>KKCRL-6 Key-In-Knob / Lever Replacement Cylinder 6-Pin "0 Bitted"</p> <p>Includes:</p> <ul style="list-style-type: none"> Standard Key / Lever Tailpiece (other tailpieces available) 2 keys (See Note B) 	<p>7PUCCRS Uncombined Small Format Interchangeable Core Conventional SFIC, 7-Pin</p> <ul style="list-style-type: none"> Does not include keys See Note C 	<p>KMCRL-4 1 1/4" 6-Pin "0 Bitted" Mortise Cylinder.</p> <ul style="list-style-type: none"> Cylinder comes with Adams Rite Cam - other cams are available as HSK. 2 keys Optional Rim Conversion Package Available See Note B & Note E
SINGLE CYLINDER DEADBOLT KITS	DOUBLE CYLINDER DEADBOLT KITS	MORTISE / RIM COMBO CYLINDER KITS
		
<p>KKCRLSD-6 Single Cylinder Deadbolt Replacement Cylinder 6-Pin "0 Bitted"</p> <p>Includes:</p> <ul style="list-style-type: none"> 2 keys (See Note B) 	<p>KKCRLDD-6 Double Cylinder Deadbolt Replacement Cylinder (2 required) 6-Pin "0 Bitted"</p> <p>Includes:</p> <ul style="list-style-type: none"> 2 keys (See Note B) 	<p>KRCRL-6 1 1/4", 6-Pin "0 Bitted" Mortise Cylinder w/ Rim Conversion Package Cylinder comes with Adams Rite Cam</p> <p>Includes:</p> <ul style="list-style-type: none"> 2 keys (See Note B)
KEY BLANKS	NOTES	
 <p>KBCRL-6 Key blanks for use with Full Size replacement cylinders</p> <p>KBCRS-7 Key blanks for use with 7PUCCRS Small Format Interchangeable Cores.</p>	<p>Notes</p> <ol style="list-style-type: none"> HSK Tier 1 and 2 Keys will operate with Tier 3 Replacement Cylinders, however the Tier 3 keys will not operate in the Tier 1 and Tier 2 High Security Cylinders. Pinning on Full Size Cylinders (CRL) is the same as Schlage, Pins, Depths & Spacing. No special pinning kits required. For pin spacing, use Scorpion HPC CX5 Card. See page 112 for Scorpion Card. Pinning on SFIC Cores (7PUC) is the same as Best, Falcon, Pins and Depth. No special pinning kits required. Cutting keys will have to be done on code machines or duplicators. These keys cannot be cut on punches. Tier 1, 2 & 3 Mortise Cylinders use the same Cams. To order other cams see HSK Cam Sheet. Optional Rim Pack is also sold separately. Part # is "Rim Pack." (Converts Mortise Cylinder to Rim Cylinder) 	

The CRP Securities High Security Key (HSK) **Patented** System utilizes the innovative Sidebar technology to bring superior and manageable Key Control. Together with distinct keyways and controlled means of key blank distribution, the Sidebar offers a superior level of Key Control Management. Keys can be cut on any standard duplicating and code cutting machines. All cylinders can be master keyed (MK), keyed-alike (KA) and keyed-different (KD). Schlage pins and depths for spacing use HPC CX5 Scorpion Card. On SFIC Cards use Best, Falcon, Pins, Depths and Spacing.

The HSK **Patented** System is designed for use in institutions, schools, hospitals, banks and all commercial and residential applications. The Sidebar series keyway is a proprietary design that is distributed in a controlled manner. Card control is implemented which requires authorized signature for valid duplication. We offer a cost-effective level of security comparable to other expensive high security control systems.

Maximum pick resistance is assured in HSK Systems with the utilization of anti-picking side pins and random mushroom top pins secured by cap screws. Standard cylinders are equipped with 2 hardened steel pins (up to 10 for UL-Listed) in the cylinder plug face for the ultimate in drill resistance. This protects the top and bottom pins and the sidebar from drilling attack.

MEETS
The Buy American Act

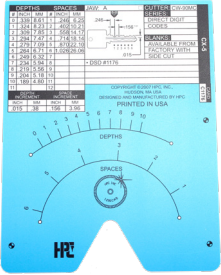
EXCLUSIVE SIDE BAR TECHNOLOGY			
Unique floating side bar pins Exclusive Keyways Patented Cylinder and Key		Pick-Resistant Spool Pins Anti-Drill Hardened Steel Pins Hardened Silver Nickel Side Bar	
KEY-IN-KNOB-LEVER CYLINDERS	SMALL FORMAT IC CYLINDERS	LARGE FORMAT IC CYLINDERS	MORTISE / RIM COMBO CYLINDERS
			
KIKL5 / KIKL6 Deadbolt/Knob/Lever, 5-Pin and 6-Pin, Universal tailpieces for locksets and deadbolts ULKIKL ANSI/BHMA A156.30 Certified UL 437- Listed for 6-Pin, Universal tailpieces for locksets and deadbolts	SFIC7 Small Format, 7-Pin ANSFIC7 ANSI/BHMA A156.30 Certified Small Format, 7-Pin	LFIC6 Schlage Large Format 6-Pin ULLFIC6 ANSI/BHMA A156.30 Certified UL 437- Listed Schlage Large Format 6-Pin	MRC118 - 1 1/8", 6-Pin ULMRC118 ANSI/BHMA A156.30 Certified UL 437- Listed, 1 1/8", 6-Pin MRC114 - 1 1/4", 6-Pin ULMRC114 ANSI/BHMA A156.30 Certified UL 437- Listed, 1 1/4", 6-Pin
Optional Keyed Different (KD), Keyed Alike (KA), Master Keyed (MK) and 0-bitted (0B)			
KEY BLANKS AND CONTROL KEYS	SFIC HOUSING	LFIC HOUSING	
			
KBL6 - 6-Pin Key Blank, Standard & Large Format KBLSF7 - 7-Pin Small Format Key Blank (SFIC) KCK6 - 6-Pin Large Format IC control key (LFIC)	 HPC CX5 Scorpion Card	MRCSFIC-1-H ANSI/BHMA A156.30 Certified Small Format IC Housing for SFIC7 and ULSFIC7 MRCLFIC-2-H Large Format IC Housing For Schlage Large Format IC LFIC6 and ULLFIC6	

KEY-IN-KNOB / LEVER (KIKL)

MEETS
The Buy American Act

- ANSI / BHMA A156.30 Certified
- UL 437 – Listed
- Retrofits all CRP-Securities cylindrical locksets and deadbolts including other popular brand names
- Unique floating sidebar pins

- Patented Cylinder plug and Key
- Exclusive Keyways
- Pick-Resistant Spool Pins
- Hardened Silver Nickel Side Bar

- 0-Bitted or Keyed Different
- Anti-Drill Hardened Steel Pins (2 – Standard, 9 – UL)
- Comes standard with different tailpieces for universal application and 2 keys

ITEM CODE	DESCRIPTION
KIKL5	Universal 5-Pin Grade 3 Key-In-Knob-Lever Cylinder
KIKL6	Universal 6-Pin Key-In-Knob-Lever Cylinder
ULKIKL6	UL 437- Listed Universal 6-Pin Key-In-Knob-Lever Cylinder

PART NO	PARTS DESCRIPTION	QTY		PART NO	PARTS DESCRIPTION	QTY
		KIKL	MRCC			
1	Key	2	2	17	Cylinder Cover	-
2	Plug	1	1	18	Sleeve	-
3	Anti-Drill Pin	*	*	19	Snap Ring	-
4	Bottom Pin	6	6	20	Plug Control Pin	-
5	Sidebar Pin	2	2	21	Pin Cover	-
6	Sidebar	1	1	22	Operation Hang Pin	-
7	Side Pin	5***	5	23	Cylinder Control Pin	-
8	Cylinder Housing	1	1	24	Operation Pin Spring	-
9	Top Pin	6**	6	25	Operation Spring	-
10	Top Pin Spring	6**	6	26	Cam	1
11	Cap Set Screw	6**	6	27	Cam Screw	1
12	Screw Cap Spring	1	-	28	Plate	1
13	Screw Cap Pin	1	-	29	Steel Ball	2
14	Tail Piece	9	1	30	Bolt	2
15	Washer	1	1	31	Screw	2
16	Screw Cap	2				

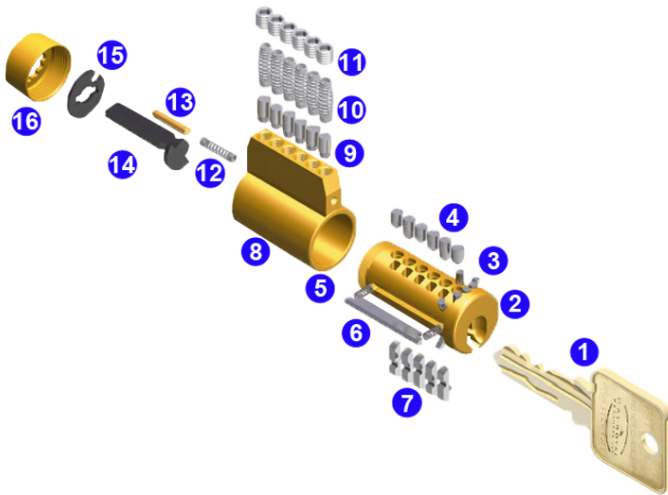

* Number of Anti-Drill Pins dependent on cylinder type (2 for Standard, 9 for UL)
 ** 5 for KIKL5
 *** 4 for KIKL6

MORTISE-RIM COMBO CYLINDER (MRCC)

MEETS
The Buy American Act

- ANSI / BHMA A156.30 Certified
- UL 437 – Listed
- 1 1/8" and 1 1/4" Mortise and Rim combination saves stocking space and inventory
- Hardened Silver Nickel Side Bar
- Pick-Resistant Spool Pins

- Cylinder rings available for 1" cylinder requirements using MRCC114 or MRC118
- Unique floating sidebar pins
- Exclusive Keyways

- 0-Bitted or Keyed Different
- Anti-Drill Hardened Steel Pins (3 – Standard, 10 – UL)
- Comes standard with 2 keys
- Patented Cylinder and Key

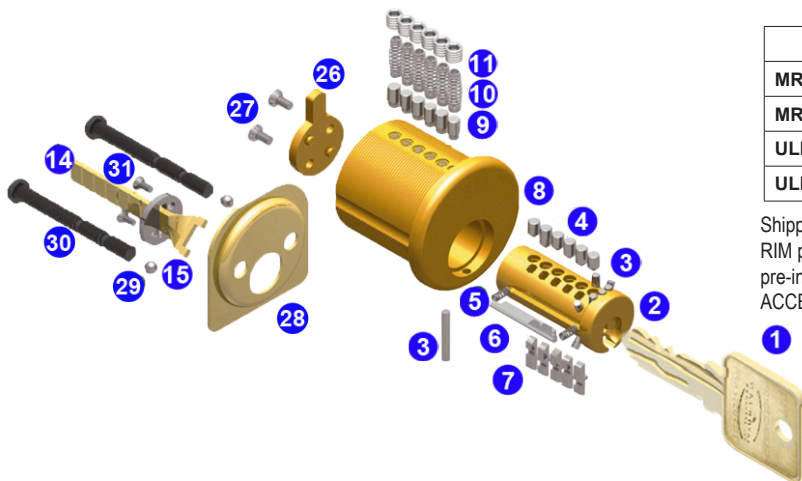

ITEM CODE	DESCRIPTION
MRC114	6-Pin 1 1/4" Mortise-Rim Combination Cylinder
MRC118	6-Pin 1 1/8" Mortise-Rim Combination Cylinder
ULMRC114	UL 437 - Listed 6-Pin 1 1/4" Mortise-Rim Combination Cylinder
ULMRC118	UL 437 - Listed 6-Pin 1 1/8" Mortise-Rim Combination Cylinder

Shipped as a mortise cylinder this is convertible to a RIM cylinder with the standard RIM pack included with the 1 1/4" and 1 1/8" mortise cylinder. An "Adams Rite" cam is pre-installed on all mortise cylinders. Other cam options are available in the KITS & ACCESSORIES section.

SMALL FORMAT INTERCHANGEABLE CORE (SFIC) CYLINDERS

MEETS
The Buy American Act

The Small Format Interchangeable Core (SFIC) cylinders are comparable to other popular SFIC in the market such as “BEST” when it comes to functionality, but with the added security of the sidebar mechanism. The location of the sidebar mechanism is inside the plug of the core, so there is no need to dismantle it to combine or pin the cylinder.

- ANSI / BHMA A156.30 Certified
- Retrofits all CRP-Securities cylindrical locksets and deadbolts including other popular brand names
- Unique floating sidebar pins
- Patented Cylinder and Key
- Exclusive Keyways
- Pick-Resistant Spool Pins
- Hardened Silver Nickel Side Bar
- 0-Bitted or Keyed Different
- Anti-Drill Hardened Steel Pins
- (2 – Standard, 4 – UL)
- Comes standard with 2 keys

ITEM CODE	DESCRIPTION
SFIC7	7-Pin Small Format Interchangeable Core Cylinder
ANSFIC7	ANSI / BHMA A156.30 Certified 7-Pin Small Format Interchangeable Core Cylinder

PART NO	PARTS DESCRIPTION	QTY		PART NO	PARTS DESCRIPTION	QTY	
		SFIC	LFIC			SFIC	LFIC
1	Key	2	2	17	Cylinder Cover	1	1
2	Plug	1	1	18	Sleeve	1	-
3	Anti-Drill Pin	*	*	19	Snap Ring	1	-
4	Bottom Pin	7	6	20	Plug Control Pin	-	1
5	Side Bar Pin	2	2	21	Pin Cover	-	1
6	Side Bar	1	1	22	Operation Hang Pin	-	1
7	Side Pin	4	5	23	Cylinder Control Pin	-	1
8	Cylinder Housing	1	1	24	Operation Pin Spring	-	1
9	Top Pin	21	6	25	Operation Spring	-	1
10	Top Pin Spring	7	6	26	Cam	-	-
11	Cap Set Screw	7	-	27	Cam Screw	-	-
12	Screw Cap Spring	-	1	28	Plate	-	-
13	Screw Cap Pin	-	1	29	Steel Ball	-	-
14	Tail Piece	-	-	30	Bolt	-	-
15	Washer	-	-	31	Screw	-	-
16	Screw Cap	-	1				

* Number of Anti-Drill Pins dependent on cylinder type (2 for Standard, 4 for UL)

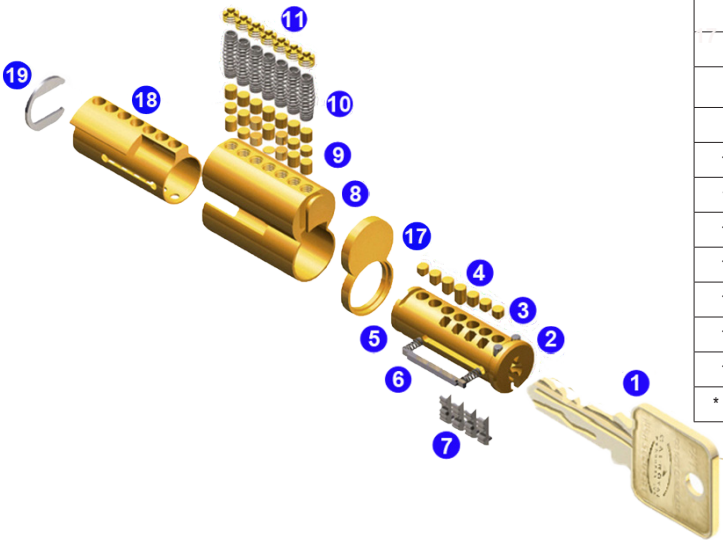

LARGE FORMAT INTERCHANGEABLE CORE (LFIC) CYLINDERS

MEETS
The Buy American Act

The Large Format Interchangeable Core (LFIC) cylinders are configured as “Schlage” format. It comes in a 6-Pin configuration.

- UL 437 – Listed
- Retrofits all CRP-Securities cylindrical locksets and deadbolts including other popular brand names
- Hardened Silver Nickel Side Bar
- Exclusive Keyways
- Pick-Resistant Spool Pins
- Patented Cylinder and Key
- Unique floating side bar pins
- 0-Bitted or Keyed Different
- Anti-Drill Hardened Steel Pins
- (2 – Standard, 9 – UL)
- Comes standard with 2 keys

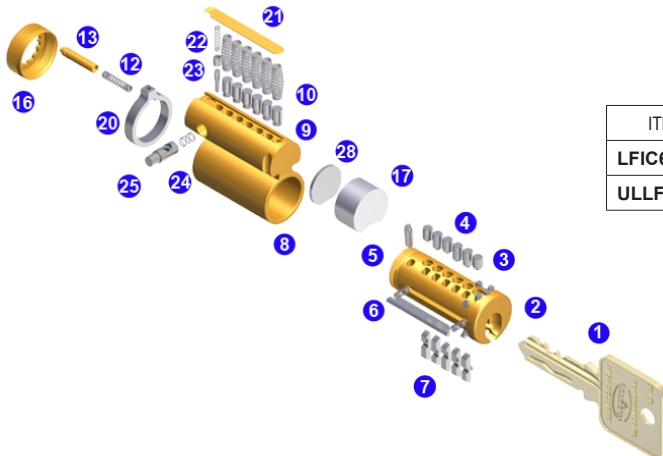

ITEM CODE	DESCRIPTION
LFIC6	6-Pin Schlage Large Format Interchangeable Core Cylinder
ULLFIC6	UL 437 - Listed 6-Pin Schlage Large Format Interchangeable Core Cylinder

SMALL FORMAT AND LARGE FORMAT INTERCHANGEABLE CORE CYLINDER HOUSING

MEETS
The Buy American Act



MRCSFIC-1-H
ANSI/BHMA A156.30 Certified
Small Format IC Housing
for SFIC7 and ULSFIC7



MRCLFIC-2-H
Large Format IC Housing
for Schlage LFIC6 and ULSFIC7

HSCRB800 AND HSCRB700 SERIES GRADE 1 HEAVY DUTY HIGH SECURITY DEADBOLT

MEETS
The Buy American Act

- Commercial and Residential Application
- Meets ADA requirements specially designed for Barrier Free Application
- Exceeds BHMA / ANSI A156.36, Grade 1 requirements
- ADA Ergonomic Thumbturn
- Available as Single or Double Cylinder
- Free turning, wrench-resistant tapered cylinder ring
- 1" (25mm) throw high-strength steel alloy deadbolt with anti-saw
- Steel mounting plate
- TRIM: Wrought Brass or Stainless Steel
- FACE PLATE: Standard 2 1/4" X 1 1/8"
- DOOR RANGES: Adjustable 1 3/8" (40mm) to 2" (51mm) door thickness
- BORE DIAMETER: 1" for latch, 2 1/8" for lock housing
- STRIKE: 1/8" X 2 3/4" square corner
- Extra security 1" throw bolt with 1/4" free spinning anti-cut through pin
- 2 pcs x 3" screws with wood frame reinforcer greatly strengthens door frames



HSCRB800
SINGLE CYLINDER DEADBOLT



HSCRB700
DOUBLE CYLINDER DEADBOLT

ALSO AVAILABLE FOR GRADE 2 DEADBOLT CYLINDERS



HSULT360



HSULT362



HSCB160



HSCB162

KEY BLANKS AND CONTROL KEYS

ITEM CODE	DESCRIPTION
KBL5	5-Pin key blank
KBL6	6-Pin key blank
KBLSF7	7-Pin Small Format IC key blank
KCK6	6-Pin Large Format IC control key



MEETS
The Buy American Act



SHTOOL
SFIC Housing Shear Tool

ACCESSORIES

MORTISE AND KIKL COMPONENTS (UL - LISTED)

	ULCAMADAM-1	ULCAMYALE-2	ULCAMYALE-2A	ULCAMRUSS-3	ULCAMFLCN-4	ULCAMSCHL-7	ULCAMSGNT-8	ULMSHRMTPIN	ALLNSCRW-SS
SSBPIN0	SSBPIN1	SSBPIN2	SSBPIN3	SSBPIN4	SSBPIN5	SSBPIN6	SSBPIN7	SSBPIN8	SSBPIN9

MORTISE AND KIKL COMPONENTS (NON-UL)

SPIN1	SPIN2	SPIN3	SPIN4	SIDEBAR-1	SIDEBARSPRING	LZTPSD-01	LZTPDD-01	LZTPDD-02
KIKLZTP-01	KIKLZTP-02	KIKLZTP-03	KIKLZTP-04	KIKLZTP-05	KIKLZTP-06	TPWASHER	MSHRMTPIN	
KIKLCAP-01	KIKLCAP-02	KIKPIN	KIKPINSRING	RIMPACK	ALLNSCRW-BLK	KIKSPRING	MRTPINSRING	
CAMADAM-1	CAMYALE-2	CAMYALE-2A	CAMRUSS-3	CAMFLCN-4	CAMSCHL-7	CAMSGNT-8	CAMSCREW	

LFC COMPONENTS

LFCAMADAM-1	LFCAMYALE-2	LFCAMYALE-2A	LFCAMRUSS-3	LFCAMFLCN-4	LFCAMSCHL-7	LFCAMSCRW

SFIC COMPONENTS

SFICSPIN1	SFICSPIN2	SFICSPIN3	SFICSIDEBAR	SFICSBSPR	SFICCLIP	SFICALLNSCRW	SFICSPR

CONTROLLED KEY DUPLICATION AND DISTRIBUTION

High Security key control is a must. Each cylinder comes with duplicate keys, registration card and authorization card. Dealers agree to keep accurate and responsible keying records in accordance with CRP Securities' recording procedures and agree to maintain a key cutting log in which Dealers will enter for each key that it cuts: the date of the key duplication, the name of the person operating the machine, the number of duplicate keys cut, the name of the person to whom the duplicate key is delivered or, if mis-cut, the fact will be recorded and the mis-cut blank will be stored in inventory until it can be counted by CRP Securities personnel and the remaining number of CRP High Security key blanks in Dealer's inventory.

These are just some of the procedures that are enforced to ensure and maintain the high level of security provided by CRP High Security Key System.

AUTHORIZATION CARD		FILE NUMBER
<i>Authorized Signatures</i>		<i>Customer</i>
1. NAME _____	COMPANY NAME _____	
1. SIGNATURE _____	STREET ADDRESS _____	
2. NAME _____	CITY _____ STATE _____ ZIP _____	
2. SIGNATURE _____	This card serves as an authorization to purchase additional CRP Securities keys and/or locks based on assigned codes. Locksmith must be notified if there are any changes in the signatories on a company letterhead bearing one of the original signatures.	
DATE _____		

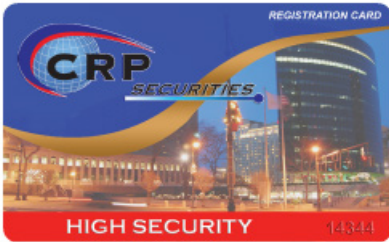







The specified Locksmith hereby authorizes its officers, employees, and agents to accept the authorized signatures appearing on the reverse side of this card to avail of services and products from CRP Securities of sensitive character such as Master Keys, Restricted Keys, Locks, etc. It is the Locksmith's responsibility to extend only under an admissible decision that an authenticated signature on any order in such events has been made by the individual whose signature is the above-mentioned authorized signature.

KEY CUTTING LOG SHEET

DATE	REGISTRATION #	CUSTOMER NAME	COMPANY	DUPLICATE QTY.	KEY SERIAL #(S)	MACHINE OPERATOR	REMARKS

CRP COMBINATION “COMBI” KEY CONTROL CYLINDER PROGRAM

COMBI is a new key system developed by Cal-Royal Products, Inc. and CRP Securities to resolve key systems using different lock manufacturers’ products to work together. Using patented keyway design, it allows for existing keying systems of different lock manufacturers to be integrated into one keyway, while maintaining existing hierarchy of key control and key combinations.

CRP COMBI CYLINDER PROGRAM			
KEY-IN-KNOB-LEVER CYLINDERS	SMALL FORMAT IC CYLINDERS	MORTISE CYLINDERS	
			
<p>KK-COS-NS Key-In-Knob / Lever Replacement Cylinder 6-Pin “0-bitted” Includes:</p> <ul style="list-style-type: none"> • Standard Key / Lever Tailpiece (other tailpieces available) • 2 keys • See Note A below for pinning info 	<p>6PUC0-COS Uncombined Small Format Interchangeable Core Conventional SFIC, 6-Pin</p> <ul style="list-style-type: none"> • Does not include keys See Note B below for pinning info 	<p>KM-COS-4 1 ¼” 6-Pin “0-bitted” Mortise Cylinder.</p> <ul style="list-style-type: none"> • Cylinder comes with Adams Rite Cam - other cams are available as HSK. • 2 keys • Optional Rim Conversion Package Available • See Note A below for pinning info 	
LARGE FORMAT INTERCHANGEABLE CORES			
SCHLAGE	YALE	SARGENT	CORBIN/RUSSWIN
			
<p>KL-COS-SC Schlage Large Format 6-Pin “0-bitted” Includes:</p> <ul style="list-style-type: none"> • 2 keys • See Note A below for pinning info 	<p>KL-COS-YA Yale Large Format 6-Pin “0-bitted” Includes:</p> <ul style="list-style-type: none"> • 2 keys • See Note A below for pinning info 	<p>KL-COS-SA Sargent Large Format 6-Pin “0-bitted” Includes:</p> <ul style="list-style-type: none"> • 2 keys • See Note A below for pinning info 	<p>KL-COS-CR Corbin / Russwin Large Format 6-Pin “0-bitted” Includes:</p> <ul style="list-style-type: none"> • 2 keys • See Note A below for pinning info
EUROPEAN PROFILE CYLINDERS			
HALF CYLINDER	DOUBLE CYLINDER	CYLINDER X THUMBTURN	
			
<p>KE-COS-S</p> <ul style="list-style-type: none"> • 1 ¾” (45mm) length, 6-Pin standard • Base material: Brass <p>Includes:</p> <ul style="list-style-type: none"> • 2 keys • See Note A below for pinning info 	<p>KE-COS-D</p> <ul style="list-style-type: none"> • 2 ¾” (70mm) length, 6-Pin standard • Base material: Brass <p>Includes:</p> <ul style="list-style-type: none"> • 2 keys • See Note A below for pinning info 	<p>KE-COS-C</p> <ul style="list-style-type: none"> • 2 ¾” (70mm) length, 6-Pin standard • Base material: Brass <p>Includes:</p> <ul style="list-style-type: none"> • 2 keys • See Note A below for pinning info 	

NOTES
<p>A. Use Combi C2 or C4 full size pins for all COMBI Cylinders except SFIC. See page 119.</p> <p>B. Keys must be cut on code machine with Best, Falcon, Depths and Spacing. Keys cannot be punched.</p>



CRP COMBI PINNING KITS

COMBI C2 / C4 Full Size Pinning Kit
DUAL COMBI A2 / A4 / C2 / C4
Small Format & Full Size Pinning Kit

ACCESSORIES

A2 SFIC PINS	A4 SFIC PINS	C2 FULL SIZE PINS	C4 FULL SIZE PINS
(2-19) Master Pins 	(1-11) Master Pins 	(2-9) Master Pins 	(1-5) Master Pins
<ul style="list-style-type: none"> • KP-I-2M• KP-I-3M• KP-I-4M• KP-I-5M• KP-I-6M• KP-I-7M 	<ul style="list-style-type: none"> • KP-I-8M• KP-I-9M• KP-I-10M• KP-I-11M• KP-I-12M• KP-I-13M 	<ul style="list-style-type: none"> • KP-I-14M• KP-I-15M• KP-I-16M• KP-I-17M• KP-I-18M• KP-I-19M 	<ul style="list-style-type: none"> • KP-I-14M• KP-I-15M• KP-I-16M• KP-I-17M• KP-I-18M• KP-I-19M
(0-9) Bottom Pins 	(0-5) Bottom Pins 	(0-9) Bottom Pins 	(0-5) Bottom Pins
<ul style="list-style-type: none"> • KP-I-0B• KP-I-1B• KP-I-2B• KP-I-3B• KP-I-4B 	<ul style="list-style-type: none"> • KP-I-5B• KP-I-6B• KP-I-7B• KP-I-8B• KP-I-9B 	<ul style="list-style-type: none"> • KP-I-10B• KP-I-11B• KP-I-12B• KP-I-13B• KP-I-14B 	<ul style="list-style-type: none"> • KP-I-15B• KP-I-16B• KP-I-17B• KP-I-18B• KP-I-19B
KP-I <ul style="list-style-type: none"> • SFIC pins for keying (same as BEST A2) 	KP-I4 <ul style="list-style-type: none"> • SFIC pins for keying (same as BEST A4) 	KP-C2 <ul style="list-style-type: none"> • Full size pins C2 large diameter cylinders 	KP-C4 <ul style="list-style-type: none"> • Full size pins C4 large format diameter cylinders

PARTS KIT FOR KK-COS-NS

PARTS KIT FOR KK-COS-NS	KEYS
KT-H-PK <ul style="list-style-type: none"> • KIKLCAP-01• KIKLCAP-02• LZTPSD-01 	<ul style="list-style-type: none"> • LZTPDD-01• LZTPDD-02• TPWASHER
<ul style="list-style-type: none"> • KIKLZTP-01• KIKLZTP-02• KIKLZTP-03 	<ul style="list-style-type: none"> • KIKLZTP-04• KIKLZTP-05• KIKLZTP-06
KBCOS6 COMBI 6-Pin key blank	COSCK COMBI 6-Pin Large Format IC control key