

SQ300 SERIES
CONTEMPORARY SQUARE
HEAVY DUTY DEADBOLTS
FOR COMMERCIAL AND RESIDENTIAL APPLICATIONS
ANSI A156.36, GRADE 2



LIFETIME WARRANTY

MEETS
The Buy American Act

Meets ADA requirements
Specially designed for
Barrier Free Application
Conforms with BHMA / ANSI
A156.36, Grade 2 Requirements,
Exceeds 150,000 Cycles

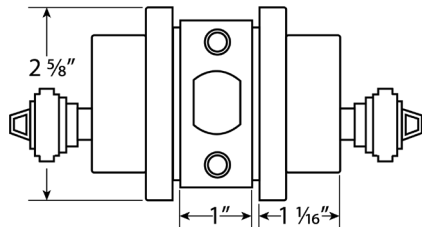
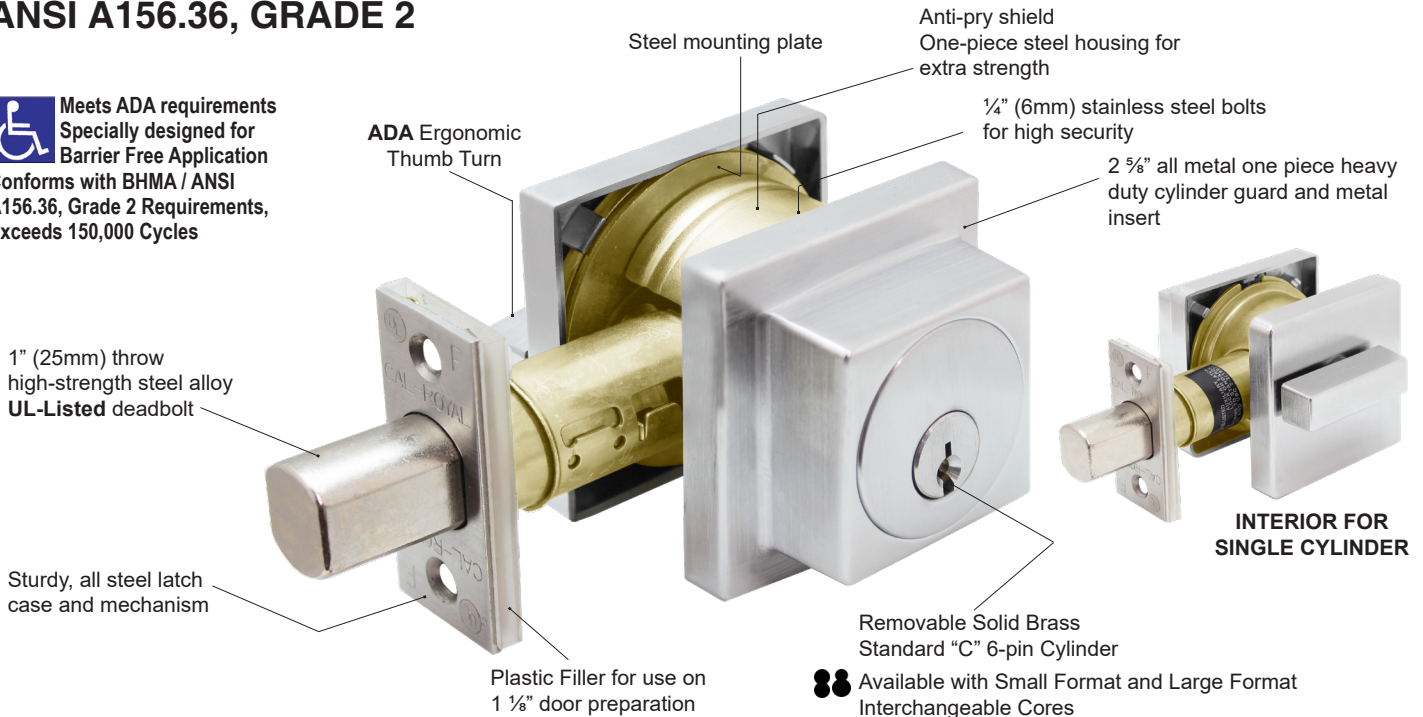

SQ-330 DOUBLE CYLINDER

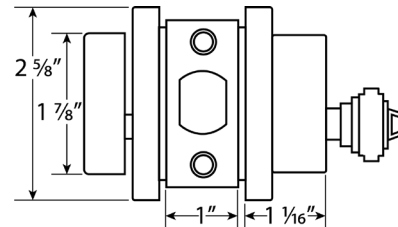

SQ-220 SINGLE CYLINDER

SPECIFICATIONS

TRIM

Wrought Brass or Zinc

DOOR RANGES

Adjustable 1 3/8" (35mm) to 1 3/4" (45mm) door thickness.

BACKSET

Adjustable UL Listed 3 Hour Fire Rating
2 3/8" or 2 3/4" latch bolt.

DEADBOLT FACEPLATE

Standard 2 1/4" x 1" packed with 1/8" plastic filler to
convert 1" face plate to 1 1/8" wide door preparations.

BORE DIAMETER

1" for latch, 2 1/8" for lock housing.

STRIKE

1 1/8" x 2 3/4" Square Corner. Extra security 1" throw bolt with 1/4" free spinning
anti-cut through pin. 2 pcs x 3" screws with wood frame reinforcer greatly
strengthens door frames.

KEYWAYS

6 pin solid brass "C" keyway standard. Schlage E, Schlage C-K,
Russwin D1-2-3-4, Corbin 59 / 60, Corbin-Russwin L4,
Sargent LA-LB-LC, Falcon / Weiser E, Arrow A, Yale 8, Yale GA and Kwikset.
Can also accept Medeco, Assa, Kaba and Cal-Royal (HSK) High Security
Cylinders.

INTERCHANGEABLE CORE

- Interchangeable Core locks will accept compatible 6 or 7-Pin cores
with BEST, FALCON and ARROW and
- Schlage Large Format Interchangeable Core.

SQ300 SERIES FINISHES AND FUNCTIONS



FINISHES AVAILABLE		
BHMA SYMBOL	US CODE	DESCRIPTION
---	US1	Black
606	US4	Satin Brass
613	US10B	Oil Rubbed Bronze
619	US15	Satin Nickel
626	US26D	Satin Chrome

Refer to price list for stock finishes and functions



LIFETIME WARRANTY

MEETS
The Buy American Act

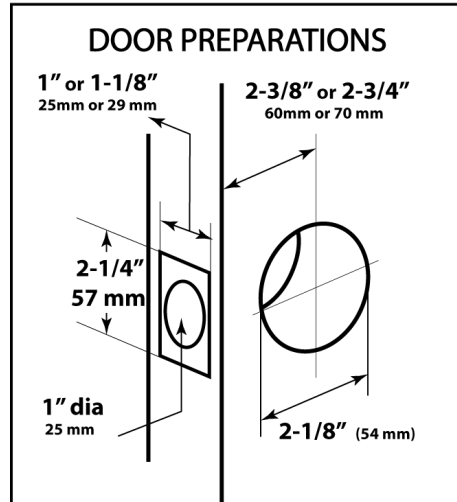

- SQ-220
 - ICSQ-220
 - ICSCSQ-220
- ANSI E0152

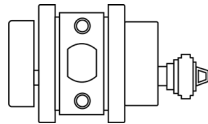

Heavy Duty Single Cylinder Deadbolt

Deadbolt thrown or retracted by key from outside or by inside turn unit. Bolt automatically deadlocks when fully thrown.

- SQ-330
 - ICSQ-330
 - ICSCSQ-330
- ANSI E0142

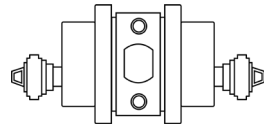

Heavy Duty Double Cylinder Deadbolt

Deadbolt thrown or retracted by key from either side. Bolt automatically deadlocks when fully thrown.

- SQ-600
 - ICSQ-600
 - ICSCSQ-600
- ANSI E0172

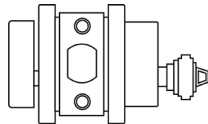

Classroom Deadbolt Lock

Deadbolt thrown or retracted by key from outside. Inside turn unit will retract bolt only. Bolt automatically deadlocks when fully thrown.

- SQ-700
 - ICSQ-700
 - ICSCSQ-700
- ANSI E1161

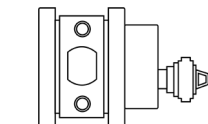

One Way Dead Bolt WITH INTERNAL PLATE

Deadbolt thrown or retracted by key only. Bolt automatically deadlocks when fully thrown. Blank plate inside (exposed screws).

SQ-363

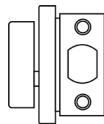

One Sided Dead Bolt

Deadbolt thrown or retracted by turn unit only. No outside trim. Bore halfway through door for installation visible from one side of door only.

SQ-365

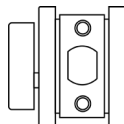

One Sided Dead Bolt WITH EXTERNAL PLATE

Deadbolt thrown or retracted by turn unit only. Blank plate is on external trim to be used on bore holes 2 1/8" wide.

OTHER FUNCTIONS NOT LISTED ARE AVAILABLE UPON REQUEST

- "IC" Indicates functions available with Interchangeable Core compatible with 6 or 7-Pin cores by Best, Falcon and Arrow.
- "ICSC" Indicates deadbolts that are available with Schlage Large Format Interchangeable Core