

TABLE OF CONTENTS

I. 900 SERIES

Barrier Free..... DC1
 Barrier Free with Delay Action..... DC1

PARTS & ACCESSORIES

ARMS

Door Closer Arms..... DC2
 Extended Long Arms..... DC2
 Hold Open Arm with Parallel Brackets..... DC2
 Non-Handed Parallel Arms..... DC2
 Slide Track Arm with Hold Open..... DC2
 Super Rigid Parallel Arm Stoppers..... DC2
 Super Rigid Parallel Arm Stopper Hold Open..... DC2

BRACKETS

Flat Drop Brackets..... DC3
 Parallel Arm Drop Brackets..... DC3

BOLTS

Sex Bolts..... DC3
 Sex Bolts for 1 3/8" Doors..... DC3
 Thru Bolts and Grommet Nuts..... DC3

COVERS

Full Covers..... DC3
 Optional Full Metal Covers..... DC3
 Slim Covers..... DC3

II. CR441 SERIES

Barrier Free (with Back Check)..... DC4
 Barrier Free with Delay Action & Back Check..... DC4
 Barrier Free with Delay Action (No Back Check)..... DC4
 Door Closer with Electronic Hold Open Track..... DC5

PARTS & ACCESSORIES

ARMS

Door Closer Arms..... DC6
 Extended Long Arms..... DC6
 Hold Open Track Arm..... DC6
 Non-Handed Parallel Arms..... DC6
 Non-Handed Hold Open Arms..... DC6
 Super Rigid Non-Handed Parallel Arms..... DC5
 Super Rigid Parallel Arm Stoppers..... DC5
 Super Rigid Parallel Arm Stopper Hold-Open..... DC5

BRACKETS

Parallel Arm Brackets..... DC7

BOLTS

Sex Bolts..... DC7
 Sex Bolts for 1 3/8" Doors..... DC7

COVERS

Plastic Covers..... DC7
 Stainless Steel Covers..... DC7
 Steel Covers..... DC7

OTHERS

CONCR441 Kit & CR441 Door Closers..... DC6
 CR441 Tandem Connector Sleeve Nuts..... DC6
 Variable-Sized Hexagonal Wrench..... DC7
 Blade Stop Spacer..... DC7
 Cush Shoe Support..... DC7

III. CR801 / CR801S SERIES

Barrier Free (Full Cover)..... DC8
 Barrier Free (Slim Cover)..... DC8
 Barrier Free with Delay Action (Full Cover)..... DC8
 Barrier Free with Delay Action (Slim Cover)..... DC8

PARTS & ACCESSORIES

ARMS

Door Closer Arms..... DC9
 Extended Long Arms..... DC9
 Hold Open Arm with Parallel Brackets..... DC9
 Non-Handed Parallel Arms..... DC9
 Slide Track Arms with Hold Open..... DC9
 Super Rigid Non-Handed Parallel Arms..... DC9
 Super Rigid Parallel Arm Stopper Hold Open..... DC8
 Super Rigid Parallel Arm Stoppers..... DC8

BRACKETS

Parallel Arm Brackets..... DC9
 Parallel Arm Drop Brackets..... DC9

BOLTS

Sex Bolts..... DC9
 Sex Bolts for 1 3/8" Doors..... DC9
 Thru Bolts & Grommet Nuts..... DC9

COVERS

Full Covers..... DC9
 Slim Covers..... DC9

DROP PLATES

Full Flat Drop Brackets..... DC9
 Slim Flat Drop Brackets..... DC9
 Wide Flat Drop Brackets..... DC9

IV. 300 SERIES

Adjustable size 1-4, Barrier Free with Delayed Action..... DC10
 Adjustable size 1-4, Barrier Free..... DC10
 Adjustable size 3-6..... DC10

TABLE OF CONTENTS

<p>PARTS & ACCESSORIES</p> <p>ARMS</p> <p>Hold Open Arm & Parallel Brackets..... DC10</p> <p>Slide Track Arm with Hold Open..... DC10</p> <p>BRACKETS</p> <p>Parallel Arm Brackets..... DC10</p> <p>Parallel Arm Drop Brackets..... DC10</p> <p>BOLTS</p> <p>Sex Bolts..... DC10</p> <p>Sex Bolts for 1 3/8" Doors..... DC10</p> <p>COVERS</p> <p>Plastic Full Covers..... DC10</p> <p>DROP PLATES</p> <p>Flat Drop Brackets..... DC10</p> <p>V. 500 SERIES</p> <p>Adjustable Size 1-5 with Back Check..... DC11</p> <p>PARTS & ACCESSORIES</p> <p>ARMS</p> <p>Hold Open Arm & Parallel Brackets..... DC11</p> <p>BRACKETS</p> <p>Parallel Arm Brackets..... DC11</p> <p>Parallel Arm Drop Brackets..... DC11</p> <p>BOLTS</p> <p>Sex Bolts..... DC11</p> <p>Sex Bolts for 1 3/8" Doors..... DC11</p> <p>Thru Bolts and Grommet Nuts..... DC11</p> <p>COVERS</p> <p>Full Stainless Steel Covers..... DC11</p> <p>Slim Plastic Full Covers..... DC11</p> <p>DROP PLATES</p> <p>Flat Drop Brackets..... DC11</p> <p>VI. 700 SERIES</p> <p>Regular / Parallel Arm Size 2..... DC12</p> <p>Regular / Parallel Arm Size 3..... DC12</p> <p>Regular / Parallel Arm Size 3 / BC..... DC12</p> <p>Regular / Parallel Arm Size 4..... DC12</p> <p>Regular / Parallel Arm Size 4 / BC..... DC12</p> <p>Regular / Parallel Arm Size 5..... DC12</p> <p>Regular / Parallel Arm Size 5 / BC..... DC12</p>	<p>PARTS & ACCESSORIES</p> <p>ARMS</p> <p>Door Closer Arms..... DC13</p> <p>Hold Open Arm with Parallel Brackets..... DC13</p> <p>BRACKETS</p> <p>Parallel Arm Brackets..... DC13</p> <p>BOLTS</p> <p>Sex Bolts..... DC13</p> <p>Sex Bolts for 1 3/8" Doors..... DC13</p> <p>Thru Bolts & Grommet Nuts..... DC13</p> <p>COVERS</p> <p>Slim Plastic Covers..... DC13</p> <p>DROP PLATES</p> <p>Flat Drop Brackets..... DC13</p> <p>VII. 400 SERIES</p> <p>Regular Arm / Parallel Arm Size 2..... DC14</p> <p>Regular Arm / Parallel Arm Size 3 w/ Back Check.... DC14</p> <p>Regular Arm / Parallel Arm Size 3..... DC14</p> <p>Regular Arm / Parallel Arm Size 4..... DC14</p> <p>Regular Arm / Smaller Body Size 3..... DC14</p> <p>PARTS & ACCESSORIES</p> <p>ARMS</p> <p>Hold Open Arm with Parallel Brackets..... DC15</p> <p>BRACKETS</p> <p>Parallel Arm Brackets..... DC15</p> <p>BOLTS</p> <p>Sex Bolts..... DC15</p> <p>Sex Bolts for 1 3/8" Doors..... DC15</p> <p>Thru Bolts & Grommet Nuts..... DC15</p> <p>COVERS</p> <p>Plastic Full Covers..... DC15</p> <p>DROP PLATES</p> <p>Flat Drop Brackets..... DC15</p> <p>VIII. DFG888 CONCEALED GLASS FLOOR DOOR CLOSER</p> <p>Floor Closer & Top Patch..... DC16</p> <p>Optional Pivots..... DC16</p>
--	---

900 Series

ANSI 156.4, GRADE 1 ADA / Barrier Free Adjustable Door Closer With Full Cover



MEETS
The Buy American Act

LIFETIME
WARRANTY

(900 Series Only, Specify Made in Korea when ordering)

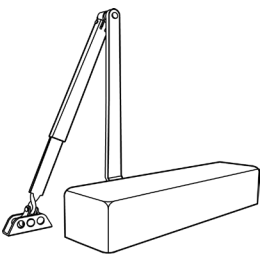
ILLUSTRATION	ITEM #	DESCRIPTION	1 CASE	5 CASES	10 CASES	PCS / MC
	N900PBF	Barrier Free, (Interior & Exterior) Adjustable size 1-6, door weights 30-260 lbs (Full Cover)	ALUM / DURO / GOLD / BLACK			6
	N900PBFDA	Barrier Free, Adjustable size 1-6, door weights 30-260 lbs with Delay Action (Interior & Exterior) (Full Cover)				

Specify "MADE IN KOREA" when ordering "THE BUY AMERICAN ACT" compliant models

STAINLESS STEEL / PLATED AND PAINTED FINISHES

PLATED FINISHES	US3, US26, US26D, US10B, US5, US4, US15, US10 In stock (Includes: Metal cover, full arm, screws and parallel bracket.)
STAINLESS COVER NEW ITEM	Stainless Steel narrow cover with matching Satin Nickel Arm & Accessories. Suffix 32D / 15 after PART#
STAINLESS STEEL COVER, ARM & PA BRACKET NEW ITEM	Stainless Steel narrow cover with matching Stainless Steel Arm & PA Bracket. Suffix 32D / 32D after PART#
PAINTED	Special colors (Allow 6-8 weeks delivery)



► PACKAGING INCLUDES

- Parallel bracket
- Wood screws and **self-tapping machine screws**
- Full cover
- Sex bolts

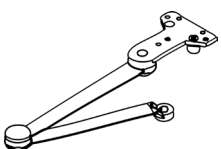
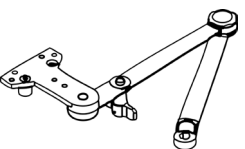
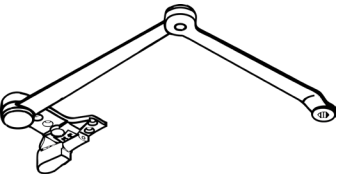
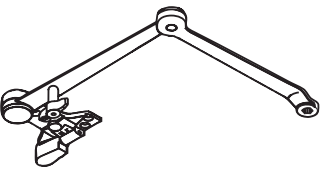
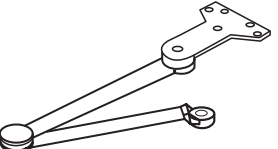
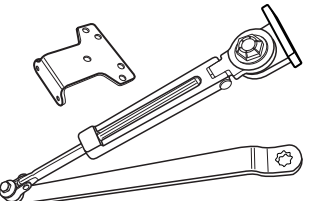
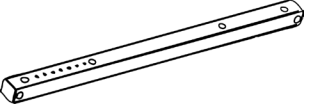
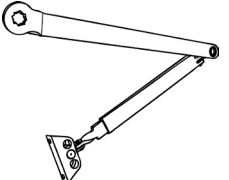

► STOCK FINISHES

- Aluminum
- Duranodic
- Gold
- Black (L1)
- US3, US26, US26D, US10B, US5, US4, US15, US10
- US32D / US15 – Cover Only with matching US15 arm
- US32D / US32D – Cover, Arm & PA Bracket

▶ PARTS & ACCESSORIES FOR 900 SERIES

ILLUSTRATION	ITEM #	DESCRIPTION
	SPAS900	Super rigid parallel arm stopper, non-handed with stop in soffit shoe. (Equivalent to LCN CUSH-N-STOP ARM)
	SPAS900 PLATED FINISH	Super rigid parallel arm stopper, non-handed US3, US26
	HOSRPS / 900	Super rigid parallel arm stopper hold-open, non-handed with stop in soffit shoe. Handle controls hold-open function. (Equivalent to LCN H-CUSH ARM)
	HOSRPS / 900 PLATED FINISH	Super rigid parallel arm stopper hold-open, non-handed US3, US26
	900SPRING	Super rigid non-handed parallel arm with spring loaded stop in the soffit shoe. (Equivalent to LCN SPRING CUSH ARM)
	900HOSPRING	Super rigid parallel arm stopper hold-open, non-handed with spring loaded stop in soffit shoe. Handle controls hold-open function. (Equivalent to LCN SPRING H-CUSH ARM)
	CR900HDAR NEW ITEM	Non-handed parallel arm features forged, solid steel main and forearm for potentially abusive installations. Equivalent to LCN 3077 EDA
	901 / 902	Hold-open arm with parallel bracket, non-handed with stop in soffit shoe.
	901 / 902 L1 (BLACK) NEW ITEM	Hold-open arm with parallel bracket, non-handed with stop in soffit shoe.
	901 / 902 PLATED FINISH	Hold-open arm with parallel bracket US3, US26
	TRACK / 900	Slide track arm with hold open
	TRACK / 900 PLATED FINISH	Slide track arm with hold open US3, US26
	945AR	Door closer arm (Main and regular forearm)
	900EXT	Extended long arm (3" extension) for top jamb with deep reveals

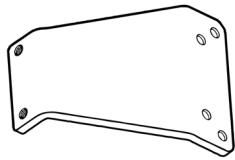
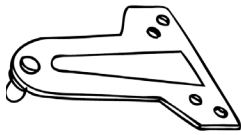
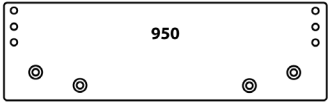
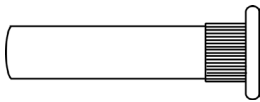
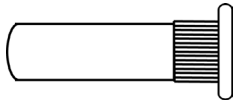
► PARTS & ACCESSORIES FOR 900 SERIES

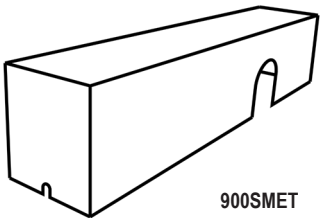
ILLUSTRATION	ITEM #	DESCRIPTION
	904	Parallel arm drop bracket for non-hold open parallel arm applications to clear a surface-applied stop / holder
	905	Parallel arm bracket
	950	Flat drop bracket
	950 PLATED FINISH	Flat drop bracket US3, US26
	970	Sex bolts, female part only 1/4" – 20 (set of 4)
	970138	Sex bolts for 1 3/8" doors, female part only 1/4" – 20 (set of 4)
	706	Thru bolts and grommet nuts (set of 4)
 900MET/900COV	900COV	Full Cover only
	900COV PLATED FINISH	Full Cover only US3, US26
	900SMET	US32D Stainless Steel (Slim Cover)
	900MET	Optional full metal cover, stock finish (Alum)
	900MET PLATED FINISH	Full Metal Cover only US3
	900SMET	

Parts and Accessories are available in other painted colors and plated finishes subject to minimum quantity and lead time.

CR441 Series

ANSI A.156.4, **GRADE 1** ADA / Barrier Free Adjustable Door Closer With Full Cover

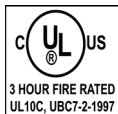

(LIFETIME WARRANTY ON DOOR CLOSER BODY ONLY)

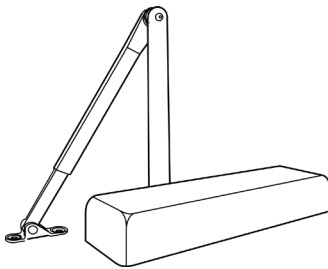
ILLUSTRATION	ITEM #	DESCRIPTION	1 CASE	5 CASES	10 CASES	PCS / MC
	CR441	Barrier free, Adjustable size 1-6 door weights 30-260 lbs (Full Cover) with Back Check				4
	CR441DA	Barrier free, Adjustable size 1-6 door weights 30-260 lbs with Delay Action (Full Cover) No Back Check				
	CR441DABC NEW ITEM	Barrier free, Adjustable size 1-6 door weights 30-260 lbs (Full Cover) with Delay Action & Back Check				

PLATED AND PAINTED FINISHES

PLATED FINISHES	US3, US26, US26D, US10B, US5, US4, US15, US10 In stock (Includes: Metal cover, full arm, screws and parallel bracket.)
STAINLESS STEEL COVER	Full Stainless Steel Cover. Suffix 32D / 15 after PART#
PAINTED	Special colors (Allow 6-8 weeks delivery)

► PACKAGING INCLUDES

- Parallel bracket
- Wood screws and **self-tapping machine screws**
- Full cover
- Sex bolts

► STOCK FINISHES

- Aluminum
- Duranodic
- Gold
- Black (L1) **NEW ITEM**
- US3, US26, US26D, US10B
- US32D – Cover Only

CR441EHO Series

ANSI A.156.4, GRADE 1, CR441 SERIES DOOR CLOSER WITH ELECTRONIC HOLD-OPEN

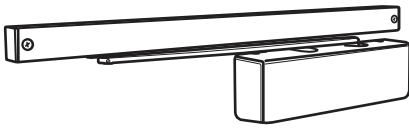
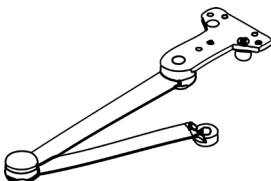
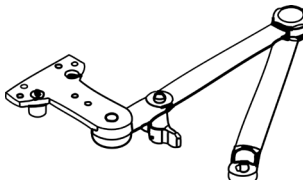
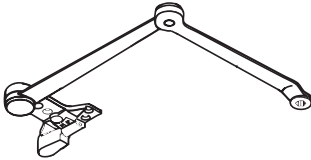
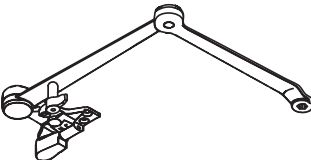

ILLUSTRATION	ITEM #	DESCRIPTION	1 CASE	5 CASES	10 CASES	PCS / MC
	CR441EHO NEW ITEM	Adjustable 1-6 Door Body with Electronic Hold-Open Track	ALUM / DURO / GOLD			4



► PACKAGING INCLUDES

- Wood screws and **self-tapping machine screws**
- Full cover
- Sex bolts

► PARTS & ACCESSORIES FOR CR441 SERIES

ILLUSTRATION	ITEM #	DESCRIPTION
	CR3077SPAS	Super rigid parallel arm stopper, non-handed with stop in soffit shoe. Equivalent to LCN CUSH-N-STOP (CUSH) ARM
	CR3049HOSRPS	Super rigid parallel arm stopper hold-open, non-handed with stop in soffit shoe. Handle controls hold open function. Equivalent to LCN HOLD-OPEN (H-CUSH) ARM
	CR3077SPRING	Super rigid non-handed parallel arm with spring loaded stop in the soffit shoe. Equivalent to LCN SPRING CUSH ARM
	3049HOSPRING	Super rigid parallel arm stopper hold-open, non-handed with spring loaded stop in soffit shoe. Handle controls hold-open function. Equivalent to LCN SPRING H-CUSH ARM

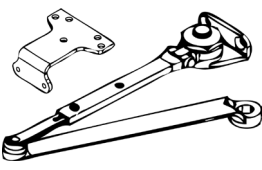
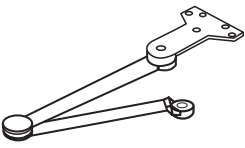

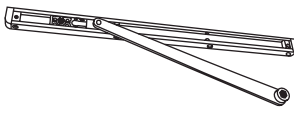
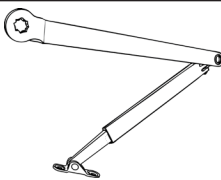

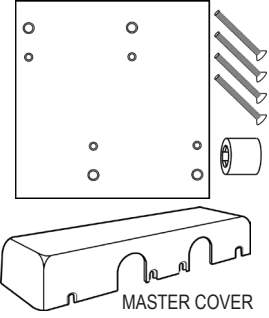
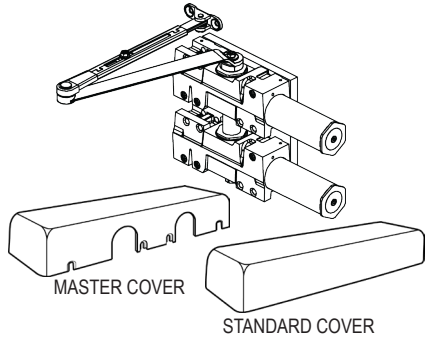

► PARTS & ACCESSORIES FOR CR441 SERIES

ILLUSTRATION	ITEM #	DESCRIPTION
	CR3049HO	Non-handed hold-open arm with parallel bracket. Equivalent to LCN 3049
	CR3049HO L1 (BLACK) NEW ITEM	
	CR3077HDAR	Non-handed parallel arm features forged, solid steel main and forearm for potentially abusive installations. Equivalent to LCN 3077 EDA
	CR441EXT	Extended long arm (3" extension) for top jamb with reveals.
	TRACK441	Hold open track arm for CR441 Door Closer
	CR441ARM	Door closer arm (Main and regular forearm)

OTHER ACCESSORIES

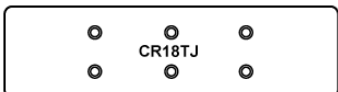
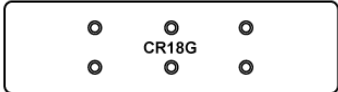
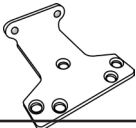
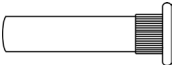
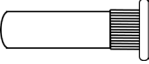
 <p>MASTER COVER</p>	CONCR441KIT NEW ITEM	CR441 tandem connector sleeve nut, mounting plate and master cover
 <p>MASTER COVER</p> <p>STANDARD COVER</p>	CR441 / TNDM NEW ITEM	1 each CONCR441 KIT 2 each of CR441 door closers

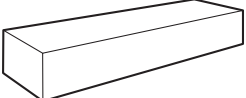
▶ PARTS & ACCESSORIES FOR CR441 SERIES

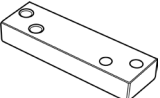
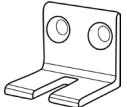
ILLUSTRATION	ITEM #	DESCRIPTION
OTHER ACCESSORIES		
	CR18PA	Drop plate for parallel arm mounting top rail is less than 5 1/2" measured from stop. Plate requires 2" minimum top rail.
	CR18	Drop plate used where top rail is less than 3 3/4"
	CR18TJ	Drop plate for top jamb where face is less than 3 1/2"
	CR18G	Drop plate for top jamb mounted closer flush with top of head frame face in flush ceiling condition. Plate requires 1 3/4" minimum head frame.
	CR441PA	Parallel Arm Bracket
	970	Sex bolts, female part only 1/4" – 20 (set of 4)
	970138	Sex bolts for 1 3/8" doors, female part only 1/4" – 20 (set of 4)
 <p>PLASTIC</p>  <p>STAINLESS STEEL</p>  <p>STEEL</p>	CR441COV	Plastic Cover Only
	CR441COV PLATED FINISH	Plastic Cover only US3
	CR441COV US32D	Stainless Steel Cover Only
	CR441COVMET28	Steel Cover (Aluminum Only)
	CRWRENCH	Variable-sized hexagonal wrench for CR3049HO Arm
	BLASS-30 NEW ITEM	Blade Stop Spacer Lower parallel arm shoe to clear 1/2" (13 mm) blade stop
	CUSSS-61 NEW ITEM	CUSH Shoe Support Provide anchorage for fifth screw used with CUSH arms where reveal is less than 3-1/16" (78 mm)

CR801 / CR801S Series

ANSI 156.4, **GRADE 1** ADA / Barrier Free Adjustable Door Closer With Full Cover

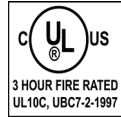

SAME HOLE PATTERN AS NORTON 8301/8501

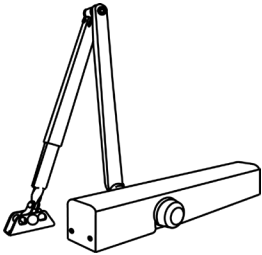
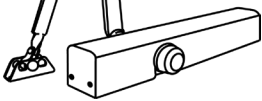
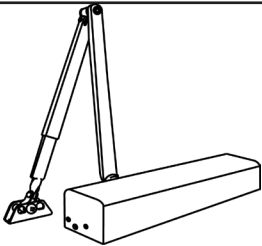
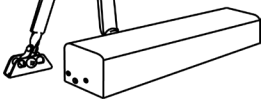
ILLUSTRATION	ITEM #	DESCRIPTION	1 CASE	5 CASES	10 CASES	PCS / MC 6
	CR801S	Barrier free, Adjustable size 1-6 (Exterior / Interior) door weights 30-260 lbs (Slim Cover)				
	CR801SDA	Barrier free, Adjustable size 1-6 (Exterior / Interior) door weights 30-260 lbs with Delay Action. (Slim Cover)				
	CR801	Barrier free, Adjustable size 1-6 (Exterior / Interior) door weights 30-260 lbs (Full Cover)				
	CR801DA	Barrier free, Adjustable size 1-6 (Exterior / Interior) door weights 30-260 lbs with Delay Action. (Full Cover)				

◆◆ Above are for Aluminum, Duro and Gold finish only ◆◆

NON-STOCK PAINTED FINISHES

PAINTED	Special colors (Allow 6-8 weeks delivery)
---------	---

► PACKAGING INCLUDES

- Parallel bracket
- Wood screws and **self-tapping machine screws**
- Slim cover (**CR801S**)
- Full cover (**CR801**)
- Sex bolts

► STOCK FINISHES

- Aluminum
- Duranodic
- Gold

► PARTS & ACCESSORIES

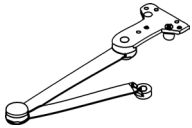
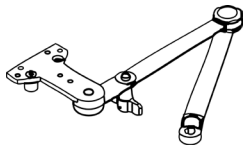
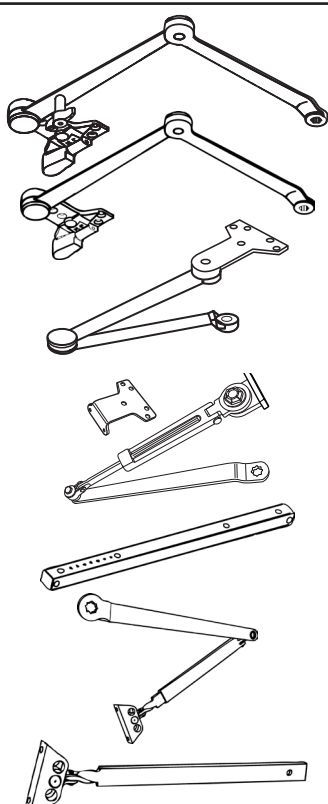

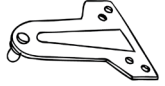
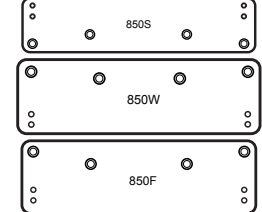

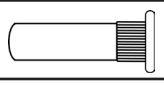

ILLUSTRATION	ITEM #	DESCRIPTION
	SPAS900	Super rigid parallel arm stopper, non-handed with stop in soffit shoe. (Equivalent to LCN CUSH-N-STOP ARM)
	HOSRPS / 900	Super rigid parallel arm stopper hold-open, non-handed with stop in soffit shoe. Handle controls hold-open function. (Equivalent to LCN H-CUSH ARM)

ILLUSTRATION	ITEM #	DESCRIPTION
	900HOSPRING	Super rigid parallel arm stopper hold-open, non-handed with spring loaded stop in soffit shoe. Handle controls hold-open function. (Equivalent to LCN SPRING H-CUSH ARM)
	900SPRING	Super rigid non-handed parallel arm with spring loaded stop in the soffit shoe. (Equivalent to LCN SPRING CUSH ARM)
	CR900HDAR NEW ITEM	Non-handed parallel arm features forged, solid steel main and forearm for potentially abusive installations. Equivalent to LCN 3077 EDA
	901 / 902	Hold-open arm with parallel bracket, non-handed with stop in soffit shoe.
	TRACK / 900	Slide track arm with hold-open
	945AR	Door closer arm (Main and regular forearm)
	900EXT	Extended long arm (3" extension) for top jamb with deep reveals
OTHER ACCESSORIES		
	904	Parallel arm drop bracket for non-hold open parallel arm applications to clear a surface-applied stop / holder
	905	Parallel arm bracket
	850S	Slim Flat drop bracket
	850W	Wide Flat drop bracket
	850F	Full Flat drop bracket
	970	Sex bolts, female part only 1/4" - 20 (set of 4)
	970138	Sex bolts for 1 3/8" doors, female part only 1/4" - 20 (set of 4)
	706	Thru bolts and grommet nuts (set of 4)
	801SCOV	Slim Cover only
	801COV	Full Cover only

300 Series

ANSI 156.4, GRADE 1 ADA / Barrier Free Adjustable Door Closer With Full Cover

Template Universal hole pattern as: Norton, Yale and Dorma Size 4

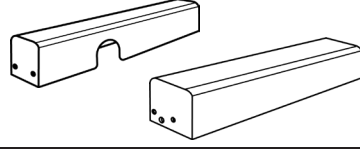
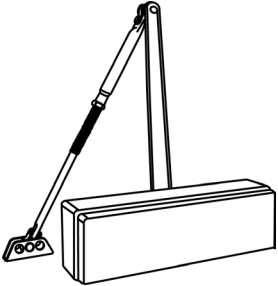
ILLUSTRATION	ITEM #	DESCRIPTION	1 CASE	5 CASES	10 CASES	PCS / MC			
	300PCOV	Adjustable size 3-6 door weights 85-260 lbs (Exterior), (Full Cover)							6
	300PBFCOV	Adjustable size 1-4 door weights 30-185 lbs Barrier free (Interior) (Full Cover)							
	300PBFDAOV	Adjustable size 1-4 door weights 30-185 lbs Barrier free (Interior) with Delayed Action (Full Cover)							

PLATED FINISHES

PLATED FINISHES | US3 In stock (Includes: Plastic cover, full arm, screws and parallel bracket.)

► **PACKAGING INCLUDES**



- Parallel bracket
- Wood screws & self-tapping machine screws
- Full cover

► **STOCK FINISHES**

- Aluminum
- Duranodic
- Gold
- US3 (Polished Brass)

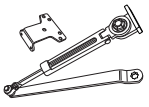
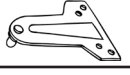
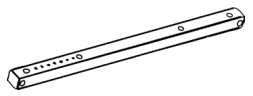
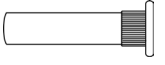
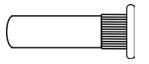
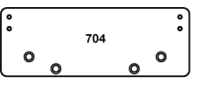
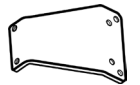

► **PARTS & ACCESSORIES**

ILLUSTRATION	ITEM #	DESCRIPTION
	301 / 302	Hold-open arm & parallel bracket
	905	Parallel arm bracket
	TRACK / 900	Slide Track Arm with Hold-Open
	970	Sex bolts, female part only 1/4" – 20 (set of 4)
	970138	Sex bolts for 1 3/8" doors, female part only 1/4"-20 (set of 4)
	704	Flat drop bracket
	904	Parallel arm drop bracket for non-hold open parallel arm applications to clear a surface-applied stop / holder
	COV / 400	Additional plastic full cover

500 Series

ANSI 156.4, GRADE 1 ADA / Barrier Free Adjustable Door Closer
With Full Cover

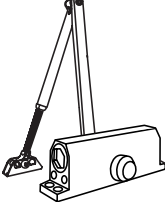

Template Universal hole pattern as: Norton, Yale and Dorma Size 4

ILLUSTRATION	ITEM #	DESCRIPTION				PCS / MC
	500PBF	Adjustable size 1-5 with Back Check Door weights 30-260 lbs (Price with without cover; optional cover available)	1 CASE	5 CASES	10 CASES	6





► **PACKAGING INCLUDES**

- Parallel bracket
- Wood screws and self-tapping machine screws

► **STOCK FINISHES**

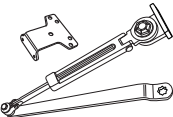
- Aluminum
- Duranodic
- Full Stainless Steel Cover

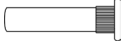
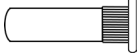
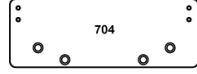
► **PARTS & ACCESSORIES**

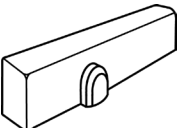
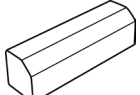
ILLUSTRATION	ITEM #	DESCRIPTION
	501 / 502	Hold-open arm & parallel bracket
	505	Parallel arm bracket
	706	Thru bolts with grommet nuts (set of 4)
	970	Sex bolts, female part only 1/4" – 20 (set of 4)
	970138	Sex bolts for 1 3/8" doors, female part only 1/4" – 20 (set of 4)
	704	Flat drop bracket
	904	Parallel arm drop bracket for non-hold open parallel arm applications to clear a surface-applied stop / holder
	500COV	Slim plastic full cover
	500COV 32D NEW ITEM	Full Stainless Steel Cover

700 Series

Dual Valve Sized Door Closers, ANSI 156.4, **GRADE 1** Optional Back Check and Cover

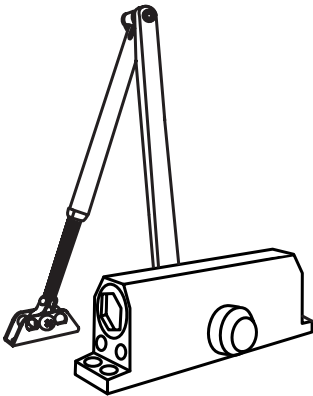

Template Universal hole pattern as: Norton, Yale and Dorma Size 4

ILLUSTRATION	ITEM #	DESCRIPTION	PCS / MC
	720	Regular / Parallel arm size 2 door weights 55-100 lbs	10
	730	Regular / Parallel arm size 3 door weights 88-143 lbs	
	730BC	Regular / Parallel arm size 3/BC door weights 88-143 lbs	
	740	Regular / Parallel arm size 4 door weights 120-187 lbs	
	740BC	Regular / Parallel arm size 4 / BC door weights 120-187 lbs	
	750	Regular / Parallel arm size 5 door weights 176-265 lbs	
	750BC	Regular / Parallel arm size 5 / BC door weights 176-265 lbs	





► **PACKAGING INCLUDES**

- Parallel bracket
- Wood screws and **self-tapping machine screws**

► **STOCK FINISHES**

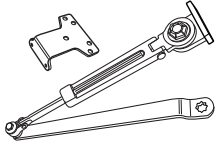
- Aluminum
- Duranodic
- Gold
- White (**740BC Only**)

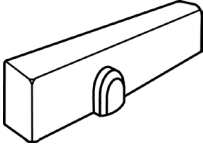
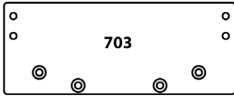
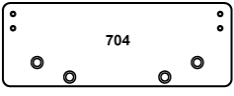
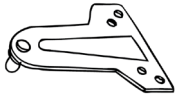
► PARTS & ACCESSORIES FOR 700 SERIES

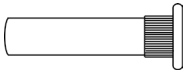
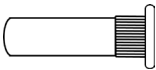
ILLUSTRATION	ITEM #	DESCRIPTION
	901 / 902	Hold-open arm with parallel bracket
	745AR	Door closer arm (Main and regular forearm)
	COV700	COV700 slim plastic cover, fits all sizes (Shipped separately)
	703	Flat drop bracket / 720, 730 (size 2, 3)
	704	Flat drop bracket / 740, 750 (size 4, 5)
	905	Parallel arm bracket
	706	Thru bolts with grommet nuts (set of 4)
	970	Sex bolts, female part only 1/4" – 20 (set of 4)
	970138	Sex bolts for 1 3/8" doors, female part only 1/4" – 20 (set of 4)

400 Series

Contender Dual Valve Sized Door Closers,
ANSI 156.4 GRADE 2 Optional Back Check and Cover



5-YEAR
WARRANTY

ILLUSTRATION	ITEM #	DESCRIPTION	PCS / MC
	420-P	Regular arm / parallel arm size 2 door weights 55 – 100 lbs	10
	SM430-P	Regular arm / Smaller body size 3 door weights 88 - 143 lbs (ALUM finish only) ACCESSORIES BELOW NOT APPLICABLE TO SM430-P	
	430-P	Regular arm / parallel arm size 3 door weights 88 - 143 lbs	
	430-PBC	Regular arm / parallel arm size 3 with back check door weights 88 - 143 lbs	
	440-P	Regular arm / parallel arm size 4 door weights 120 - 187 lbs	





► **PACKAGING INCLUDES**

- Parallel bracket
- Wood screws and **self-tapping machine screws**

► **STOCK FINISHES**

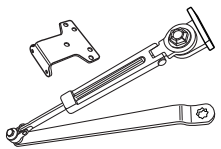
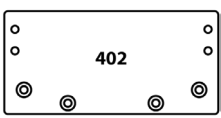
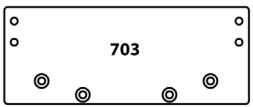
- Aluminum
- Duranodic
- Gold
- White (**430-P Only**)

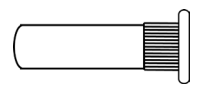
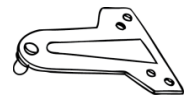
▶ PARTS & ACCESSORIES FOR 400 SERIES

ILLUSTRATION	ITEM #	DESCRIPTION
	301 / 302	Hold-open arm with parallel bracket
	402	Flat drop bracket / 420-P (size 2)
	703	Flat drop bracket / 430-P (size 3) and 440-P (size 4)
	706	Thru bolts with grommet nuts (set of 4)
	970	Sex bolts, female part only 1/4" - 20 (set of 4)
	970138	Sex bolts for 1 3/8" doors, female part only 1/4" - 20 (set of 4)
	905	Parallel arm bracket
	COV / 400	Plastic full cover, fits all sizes (shipped separately)

DFG888

CONCEALED GLASS FLOOR DOOR CLOSER

5-YEAR WARRANTY

- ▶ Maximum opening angle: 150° for both left and right opening (double action)
- ▶ Hold-Open Feature @ 90°. Optional Non Hold-Open. Stock item with Hold-Open Feature
- ▶ Two Speed Adjustments. Closing Speed (150°~10°). Latching Speed (10°~ 0°)
- ▶ Easy installation with base seat adjustable for ± 0.12" (±3mm) backward and forward, ± 0.12" (±3mm) left and right, and 4° alignment allowance for adjustment

Must order Floor Closer (DFG888), Top Patch (DPF-2) and either one of the pivots.
Specify type of pivot upon ordering.

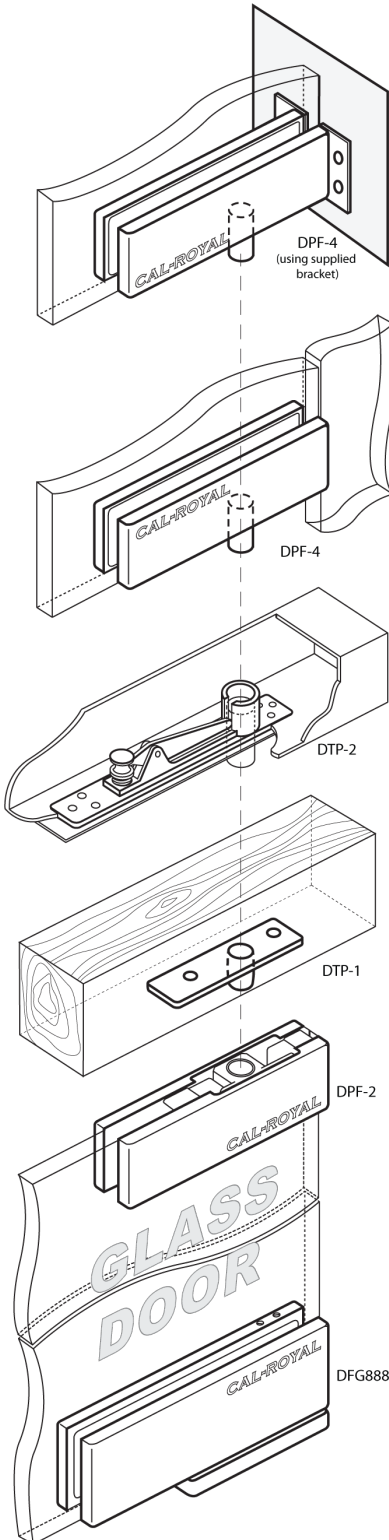

FLOOR CLOSER & TOP PATCH

ITEM #	DESCRIPTION	FINISH
DFG888	Concealed Floor Closer Capacity: Max 220 lbs (100 kgs) Door Width: 29.5" - 39.4" (750-1000mm) Door Thickness: 0.3" - 0.5" (8-13mm)	Satin Stainless Steel (US32D)
		Dark Bronze (DURO)
DFG888-NHO	Concealed Floor Closer Non-Hold Open Capacity: Max 220 lbs (100 kgs) Door Width: 29.5" - 39.4" (750-1000mm) Door Thickness: 0.3" - 0.5" (8-13mm)	Satin Stainless Steel (US32D)
		Dark Bronze (DURO)
DPF-2	Top Patch (door). Door Thickness: 0.3" - 0.5" (8-13mm)	Satin Stainless Steel (US32D)
		Dark Bronze (DURO)

DFG888, DFG888-NHO and DPF-2 are sold separately.

▶ PARTS & ACCESSORIES (OPTIONAL PIVOTS)

ITEM #	DESCRIPTION	FINISH
DTP-1	Optional Top Pivot. Used on Solid Door Frames	Satin Stainless Steel (US32D)
		Dark Bronze (DURO)
DTP-2	Optional Adjustable Top Pivot. Used on Hollow Door Frames	Satin Stainless Steel (US32D)
		Dark Bronze (DURO)
DPF-4	Over-panel Patch Used on glass walls or glass overhead panels. Bracket supplied if used on overhead glass panels with a perpendicular concrete or solid wall.	Satin Stainless Steel (US32D)
		Dark Bronze (DURO)

Pivots are sold separately. Specify type of pivot upon ordering.

DFG888 FEATURES

Angle of opening	150°
Hold-Open	90°
Closing Speed	Adjustable
Latching Speed	Adjustable
Handing	Non-Handed
Dimensions	Length: 7.32" (186mm) Width: 2.68" (68mm) Thickness: 1.42" (36mm)

