

1. A. Mark door with template at desired height.
B. Cut out notch.

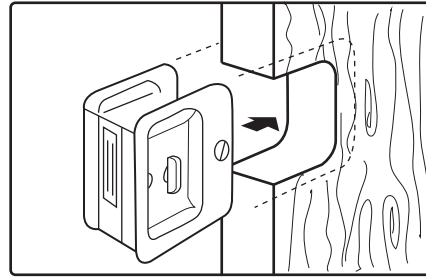

2. A. Slip lock into notch and position correctly.

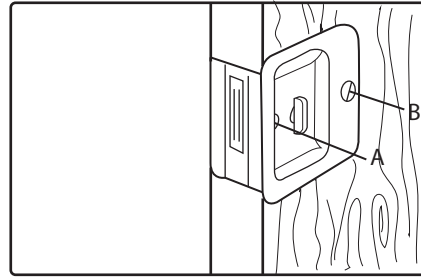

3. A. Tighten machine screws (A) on both side of door.
B. Install wood screws (B) on both sides of door.

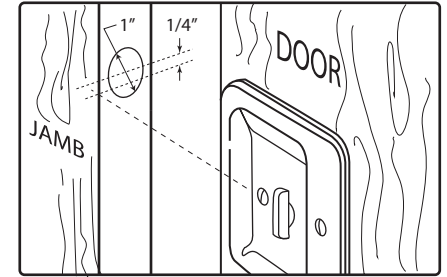

4. A. Mark horizontal center line on jamb opposite center line of lock.
B. Locate and mark vertical center line.
C. Mark point on vertical center line 1/4" (6mm) above horizontal center line.
D. Bore 1" (25mm) diameter hole 1/2" (13mm) deep at this point.

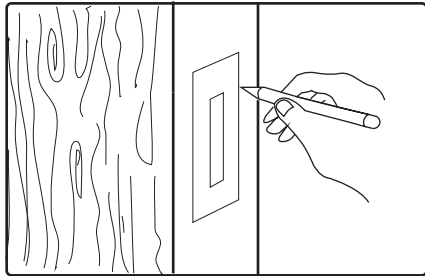

5. A. Place strike plate on door frame centered over 1" (25mm) hole drilled in step 4D.
B. Outline the strike plate on the door jamb.

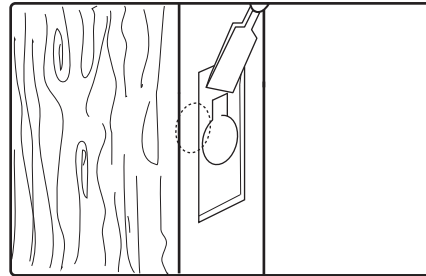

6. A. Mortise jamb for strike 1/32" deep.
B. Cut slight notch at top of the 1" hole for clearance of latch arm.

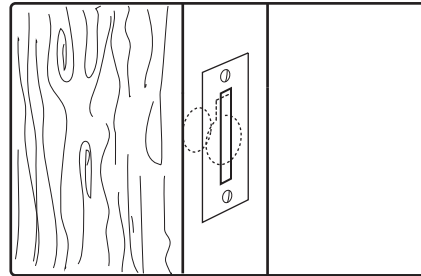

7. A. Install strike as shown.

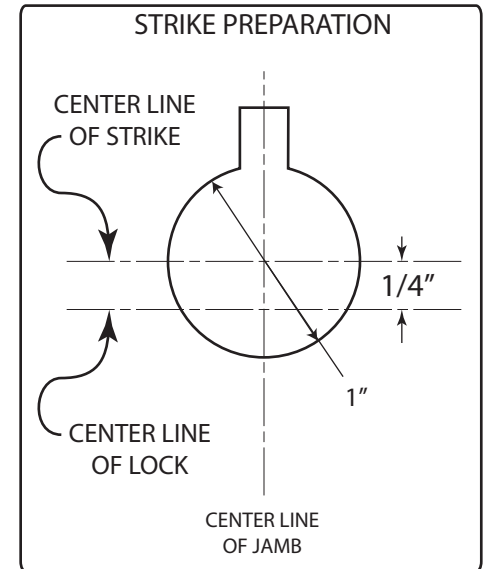

INSTALLATION INSTRUCTIONS FOR SDL16 & SDL17



6605 Flotilla St.
City of Commerce
CA 90040 USA
Tel: (323) 888-6601
FAX: (323) 888-6699
Website: cal-royal.com
Email: sales@cal-royal.com

ITEM NO.	DESCRIPTION	ANSI	SCALE	UNIT	VERSION
SDL16 SDL17	INSTALLATION INSTRUCTIONS	---	1 : 1	inches (mm)	ver. 1.0 rev. 01/12
			PAGE 1 OF 1		BY: bteves/adg