

INSTALLATION INSTRUCTION FOR #424 MULLION

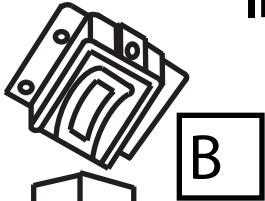

1. Secure bottom retainer **A** onto surface of finished floor using (2) two 3" flat head sleeve anchor screws.
2. Measure and cut mullion **C**, if necessary, to achieve exact fit.
3. Attach top retainer **B** onto top of mullion and locking it using the set screw before securing it with (4) four 1/4"#20x5/8" flat head machine screws on to the surface of the door stop.
4. Lock mullion in place by tightening set screws in bottom retainer **A**.
5. Measure height of strike from finished floor. (41-1/2" standard height for 9800 & 2200 exit devices.)
6. Drill and tap for strike.
7. Position and secure strike.

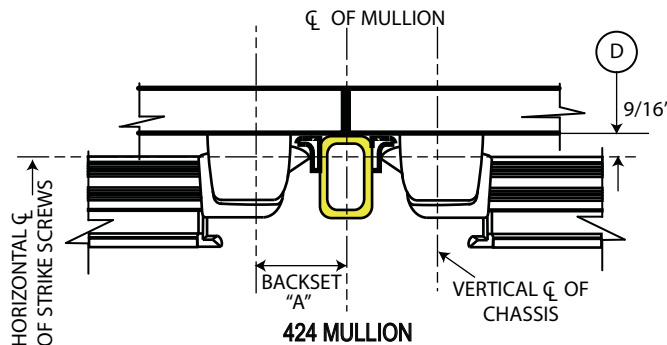
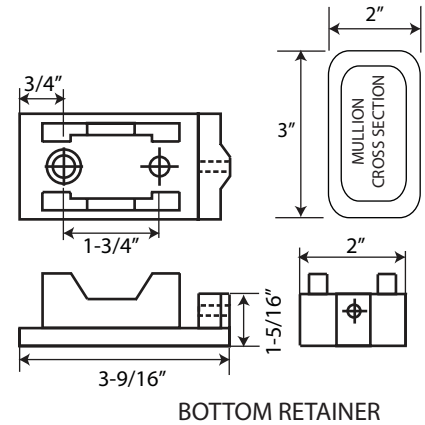
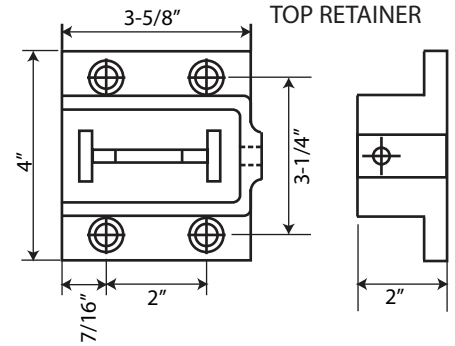

MINIMUM CLEAR STILE REQUIREMENTS				
TRIM AND MULLION				
EXIT DEVICE	BACKSET "A"	ET/STS	PTB/PSB	FLW/FSW MAL/MSL
2200	3-1/4"	4-1/2"	5"	4-9/16
5000				
9800				
7700	2-7/8"			
4400				

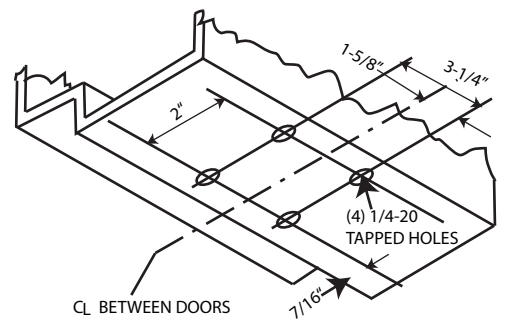

NOTES:

- *Once the strike has been installed and adjusted, drill and tap two (2) #10-24 round head machine screws
- *When using door silencers on the frame decrease **(D)** by silencer height e.g. [9/16" less silencer height]
- * For "GLASS BEAD" shims, increase **(D)** by the shim height e.g. [9/16" plus shim height]

