

AN INCORRECTLY INSTALLED OR IMPROPERLY ADJUSTED DOOR CLOSER CAN CAUSE PROPERTY DAMAGED OR PERSONAL INJURY THESE INSTALLATION INSTRUCTIONS SHOULD BE FOLLOWED TO AVOID THE POSSIBILITY OF MISAPPLICATION OR MISADJUSTMENT

Hold Open Door Closers

Model 300 Series

Surface Mounted

Adjustable & Preset "Back-Check"

Optional BF/DA

Installation Instructions

Note: For Special Applications a separate door and frame preparation template is packed with these instructions. Use this instruction sheet for installation sequence and closer adjustments only.

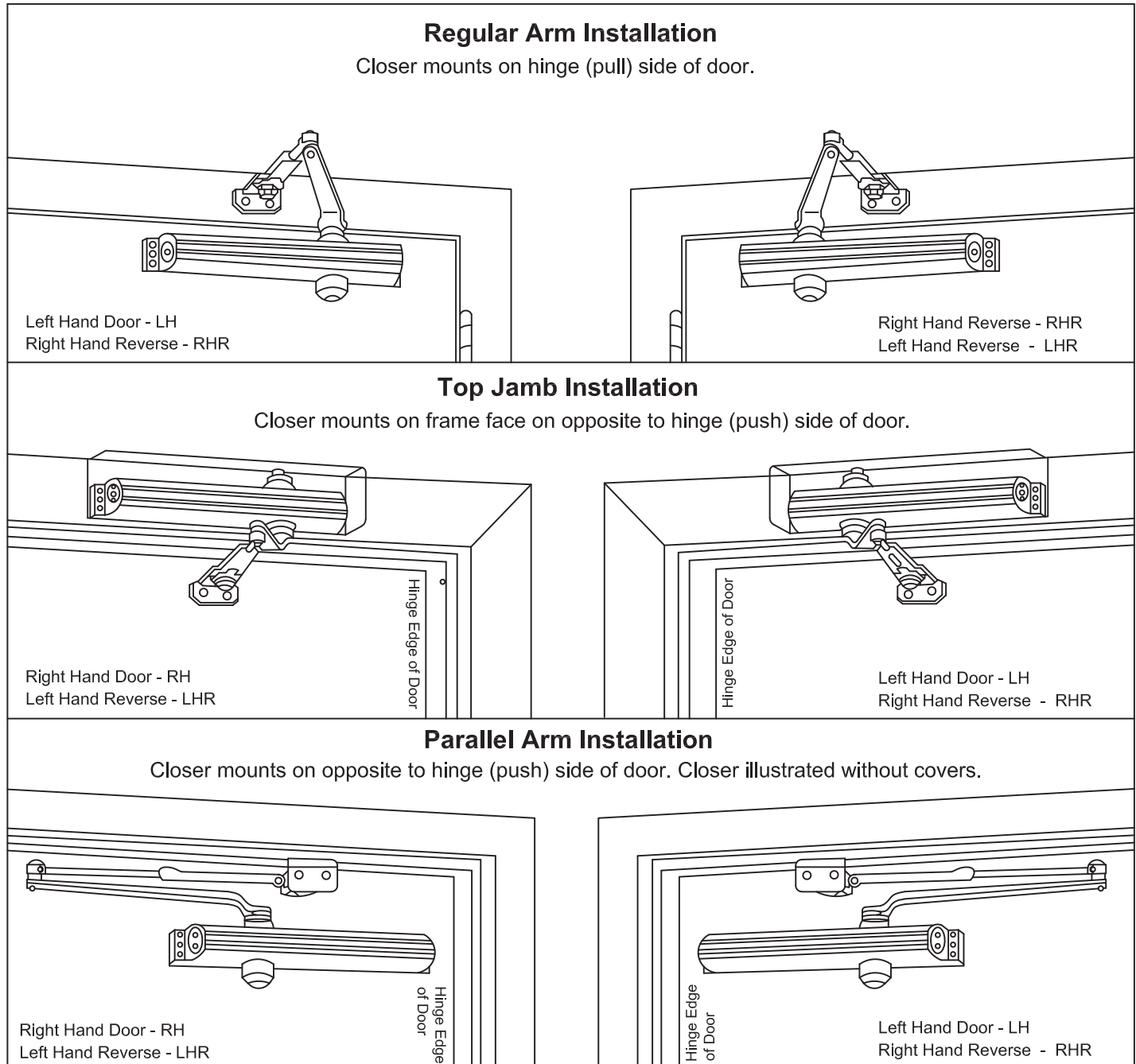

CAL ROYAL PRODUCTS INC. (HARDWARE DIVISION)
6605 FLOTILLA AVE. CITY OF COMMERCE, CA 90040 U.S.A
E-MAIL: sales@cal-royal.com
PHONE: 323-888-6601 FAX: 323-888-6699

Components

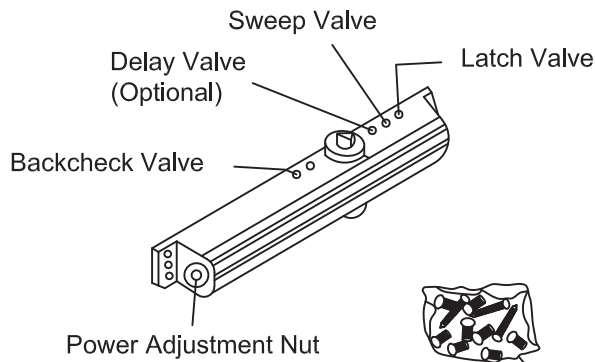

Closer Body

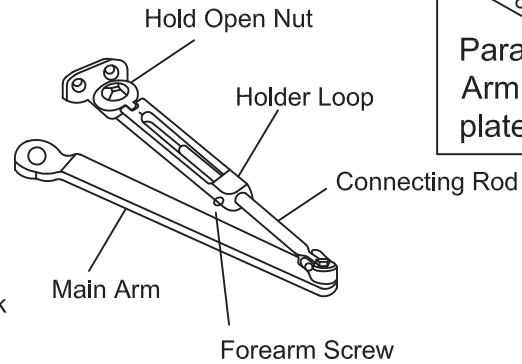

Closer Arm

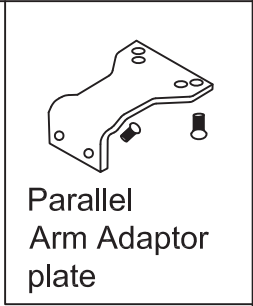

Parallel Arm Adaptor plate

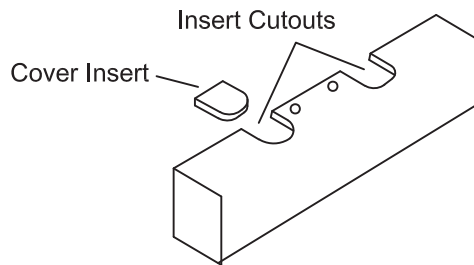

Standard Full Cover

Preparation for Fasteners

		Fasteners	Door or Frame	Drill - Sizes
Standard	# 14type "a" S.M. screw Arm: 1-1/4" (32mm) Closer: 1-1/2" (38mm)		Wood	7/32" (5.50mm)
	1/4" - 20 machine screw		Metal	drill: #7 (.201" dia.) tap: 1/4" -20
Optional	Sex nuts and bolts		Hollow Metal	9/32" (7.00mm) through 3/8" (9.50mm) on door opposite to closer
			Aluminum or Wood	3/8" (9.50mm) through
	Through - bolts and grommet - nuts		All	9/32" (7.00mm) through 3/8" (9.50mm) dia. X 3/8" (9.50mm) deep on door opposite to closer



Surface Mounted
 Adjustable & Preset "Back-Check"
 300 Series
 Hold-Open door closers
 Optional BF/DA

Installation Instructions for REGULAR ARM(PULL SIDE) Mounting

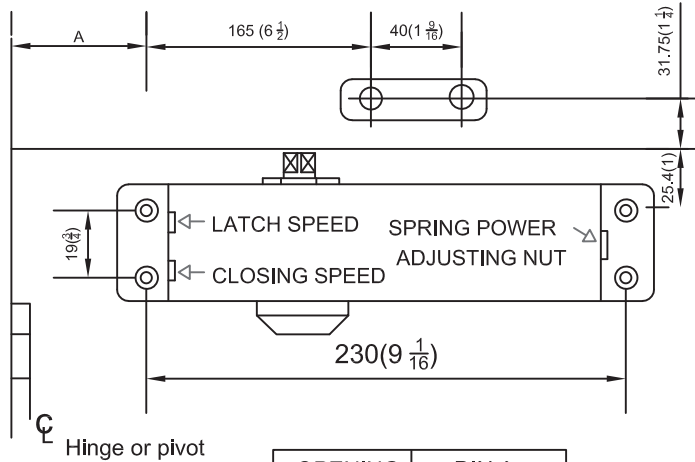

OPENING	DIN.A
TO 100°	120mm(4-23/32)
100°-120°	120mm(4-23/32)
OVER 180°	80mm(3-5/32)

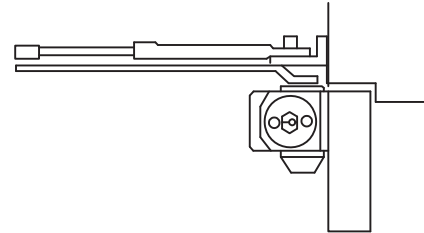

Do Not Scale Drawing
 Right Hand Door Shown
 Same dimensions apply for Left
 Hand Door measured from centerline
 of pivot point
 Dimensions are in inches
 (mm)

INSTALLATION INSTRUCTIONS

1. Select degree of opening from table and use template dimensions shown in above mark 4 holes on door for door closer and two (2) holes on frame for arm shoe.
2. Drill pilot holes in door and frame for #14 all-purpose screws or drill and tap for 1/4-20 machine screws.
3. Install adjustable forearm/arm shoe assembly to frame using screws provided.
4. Install main arm to top pinion shaft using screw provided.
5. Mount closer on door using screws provided, SPRING POWER ADJUSTING NUT MUST BE POSITIONED AWAY FROM HINGE EDGE.
6. Adjust length of adjustable forearm so that adjustable forearm is perpendicular to frame when assembled to preloaded main arm (illustration below). Secure forearm to main arm with screw provided.
7. Snap pinion cap over shaft at bottom of closer, (When using full cover, pinion cap is not necessary).
8. Adjust closing speed, back check control and spring power of door, following instructions as shown page 4.

*Remove hold open bracket and holder loop from arm assembly. Fasten hold open bracket and holder loop to frame. Hold Open Nut UP on Right Hand door. Hold Open Nut DOWN on Left Hand door.

Top View Typical Installation

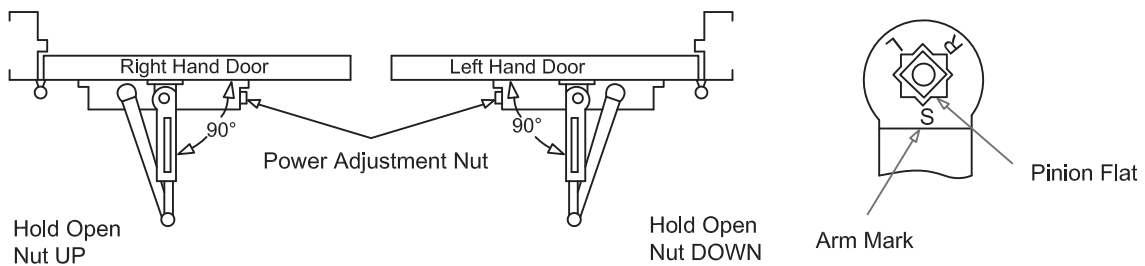



Surface Mounted
Adjustable & Preset "Back-Check"
300 Series
Hold-Open door closers
Optional BF/DA

Installation Instructions for TOP JAMB(PUSH SIDE) Mounting

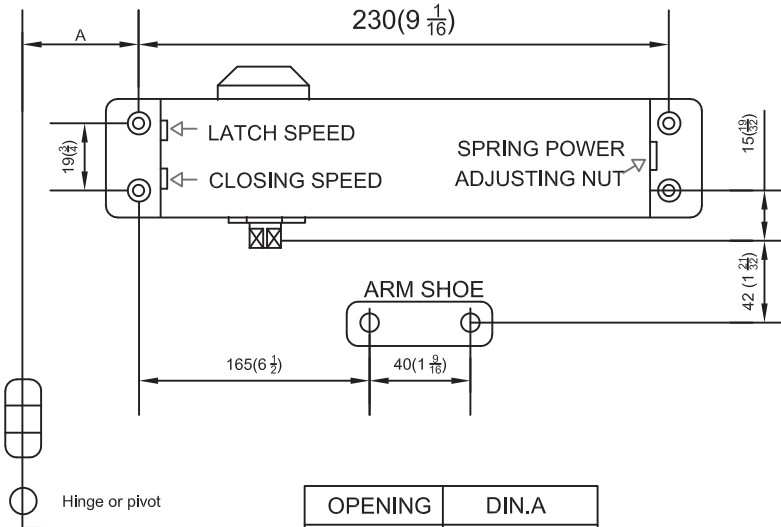

OPENING	DIN.A
TO 100°	140mm(5-1/2)
100°-120°	130mm(5-1/8)
OVER 180°	90mm(3-17/32)

Do Not Scale Drawing
Left Hand Door Shown
Same dimensions apply for Right Hand Door measured from centerline of pivot point
Dimensions are in inches
(mm)

INSTALLATION INSTRUCTIONS

1. Select degree of opening from table and use template dimensions shown in above mark 4 HOLES ON FRAME for close and two (2) HOLES ON DOOR for arm shoe.
2. Drill pilot holes in door and frame for #14 all-purpose screws or drill and tap for 1/4-20 machine screws.
3. Install adjustable forearm/arm shoe assembly to door using screws provided.
4. Install main arm to top pinion shaft using screw provided.
5. Mount closer body on frame using screws provided, SPRING POWER ADJUSTING NUT MUST BE POSITIONED AWAY FROM HINGE EDGE.
6. Adjust length of adjustable forearm so that adjustable forearm is perpendicular to door when assembled to preloaded main arm (illustration below). Secure forearm to main arm with screw provided.
7. Snap pinion cap over shaft at bottom of closer, (When using full cover, pinion cap is not necessary).
8. Adjust closing speed, back check control and spring power of door, following instructions as shown page 4.

*Remove hold open bracket and holder loop from arm assembly. Fasten hold open bracket and holder loop to door. Hold Open Nut UP on Left Hand door. Hold Open Nut DOWN on Right Hand door.

Top View Typical Installation

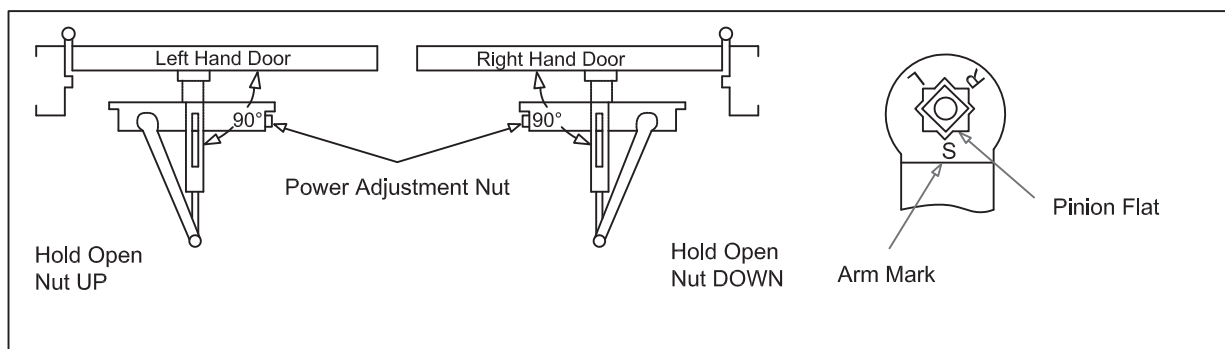

Installation Instructions for PARALLEL ARM(PUSH SIDE) Mounting

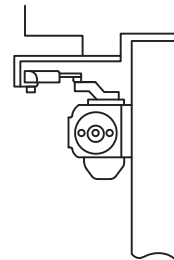
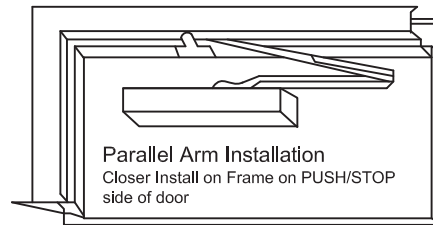
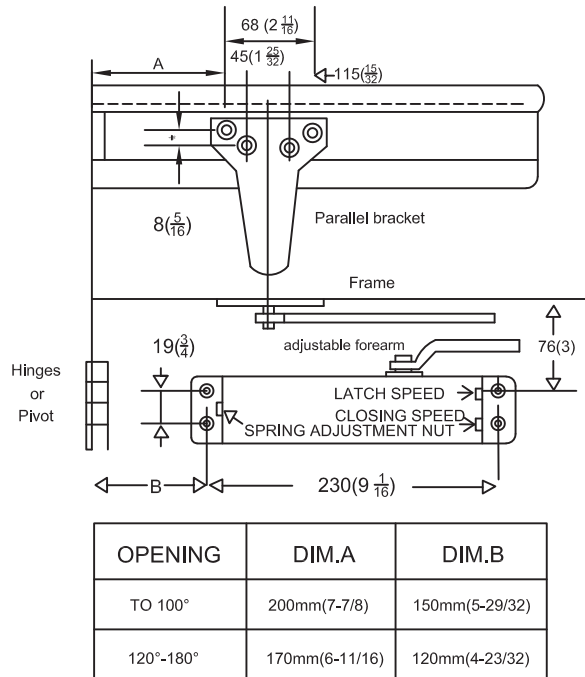

Do Not Scale Drawing
Left Hand Door Shown
Same dimensions apply for Right Hand Door measured from centerline of pivot point
Dimensions are in inches
(mm)

INSTALLATION INSTRUCTIONS

- Select degree of opening from table and use template dimensions shown in above mark 4 HOLES ON FRAME for door close and four (4) underside of frame for bracket.
- Drill pilot holes in door and frame for #14 all-purpose screws or drill and tap for 1/4-20 machine screws.
- Mount closer on door using screws provided, SPRING POWER ADJUSTING NUT MUST BE POSITIONED TOWARD HINGE EDGE.
- Install Parallel Armed Bracket to Frame Using screw provided.
- Using a wrench on the square shaft at bottom of closer, rotate shaft approximately 45° toward hinge edge of door. Hold and place main arm of shaft on top of closer at proper index mark as illustrated, FOR LEFT HAND DOOR "L" (Illustration "A"). FOR RIGHT HAND DOOR "R"(Illustration "B"). Tighten arm screw with lockwasher securely.
- Remove arm shoe from the forearm and discard (arm shoe is not used for parallel installation) and tighten screw securely.
- Adjust length of adjustable forearm so that adjustable forearm is parallel to frame.
- Snap pinion cap over shaft at bottom of closer. (When using full cover, pinion cap is not necessary).
- Adjust closing speed, back check control and spring power of door, following instructions as shown page 4.

*Remove hold open bracket and holder loop from arm assembly. Assemble adaptor plate to hold open bracket. Hold Open Nut UP on Left Hand door. Hold Open Nut DOWN on Right Hand door. Fasten assembled adaptor plate and hold open bracket to soffit.

Top View Typical Installation

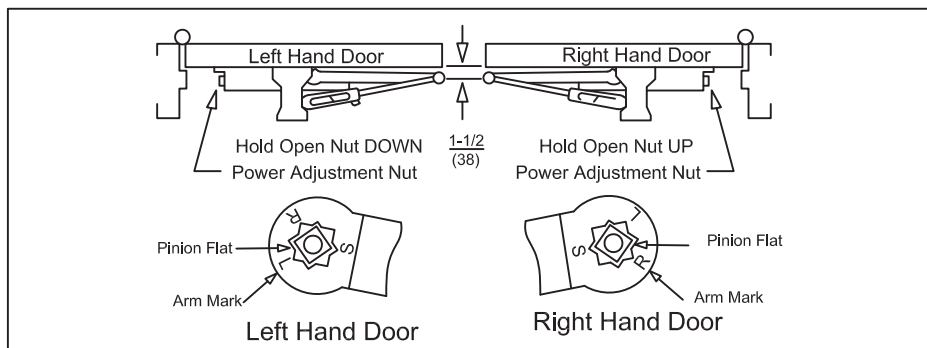

NOTE: To install main arm, pinion shaft must be rotated in excess of 50° to permit alignment with proper arm mark.



Surface Mounted
 Adjustable & Preset "Back-Check"
 300 Series
 Hold-Open door closers
 Optional BF/DA

CLOSER ADJUSTMENT

CLOSING CYCLE

NOTE: Closing arcs ("CLOSE" and "LATCH") are controlled by two(2) separate speed adjusting valves, adjust the CLOSING speed first, then adjust the LATCHING speed.

1. "CLOSING" speed adjustment is accomplished by full rotations of the speed adjusting valve.
 - Turn the speed adjusting valve CLOCKWISE for a SLOWER closing speed.
 - Turn the speed adjusting valve COUNTER-CLOCKWISE for a FASTER closing speed.
2. "LATCH" speed adjustment is accomplished by full rotation of the speed adjusting valve.
 - Turn the speed adjusting screw CLOCKWISE for a SLOWER latching speed.
 - Turn the speed adjusting screw COUNTER-CLOCKWISE for a FASTER latching speed.

CAUTION!! Do not turn speed adjusting valve more than two(2) full turns counter-clockwise from its factory set position, as two speed adjusting valves could become dislodged from the door closer body resulting in the loss of internal fluid and failure of the device.

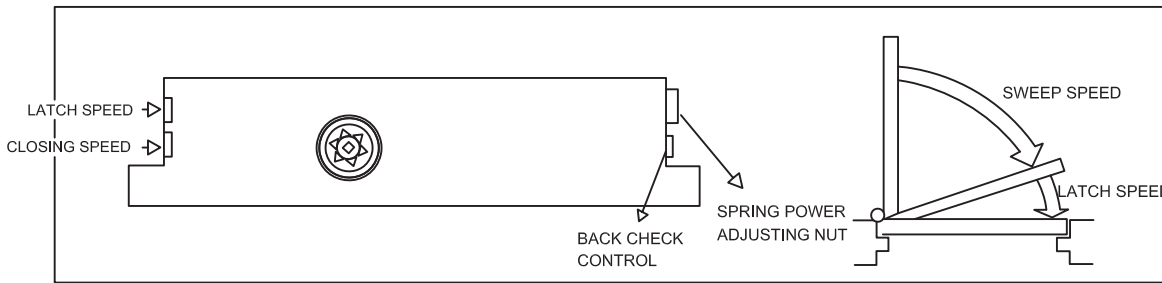

BACK CHECK CONTROL

- To increase back check intensity turn, back check control valve clockwise.
- To decrease back check intensity, turn back check valve anticlockwise.

SPRING POWER CONTROL

- To increase opening force and closing force, turn the spring adjusting nut clockwise.
- To decrease opening force and closing force, turn the spring adjusting nut anticlockwise.

FULLY ADJUSTABLE SPRING

(300 SERIES CLOSERS ARE SHIPPED AS SIZE 2 ON BF (BARRIER FREE) MODELS, AND SIZE 3 ON NON BF MODEL.) ROTATE SPRING ADJUSTMENT NUT COUNTER - CLOCKWISE TO REDUCE THE SIZE, ROTATE SPRING ADJUSTMENT NUT CLOCKWISE TO INCREASE SPRING POWER.

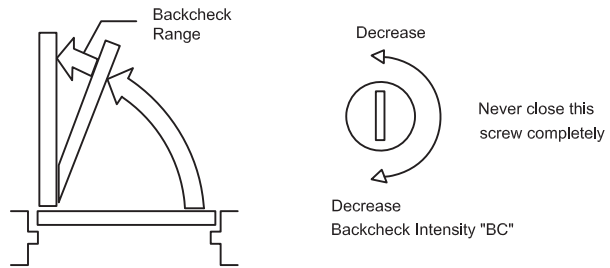

ADJUSTABLE SPRING MODELS

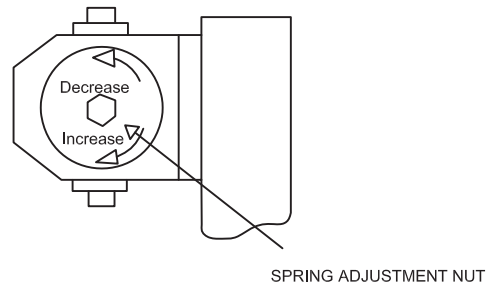

NOTE: MAXIMUM ADJUSTMENT IS APPROXIMATELY 18 TURNS FROM MINIMUM SETTING
 DO NOT FORCIBLY EXTEND ADJUSTMENT BEYOND LIMITS

CLOSER SIZE		CLOCKWISE TURNS OF ADJUSTING NUT
BC	BF	
3	1	0
4	2	6
5	3	12
6	4	18