

DE7700 Series

GRADE 1 Delayed Egress All in One Exit Device

ANSI BHMA A156.24 Delayed Egress Locking System Approved



MEETS
The Buy American Act



5-YEAR WARRANTY

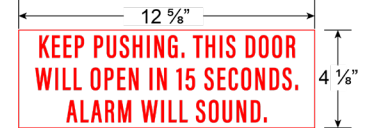

NOTE: STANDARD PACKAGING INCLUDES DECAL STICKER ON DOOR.

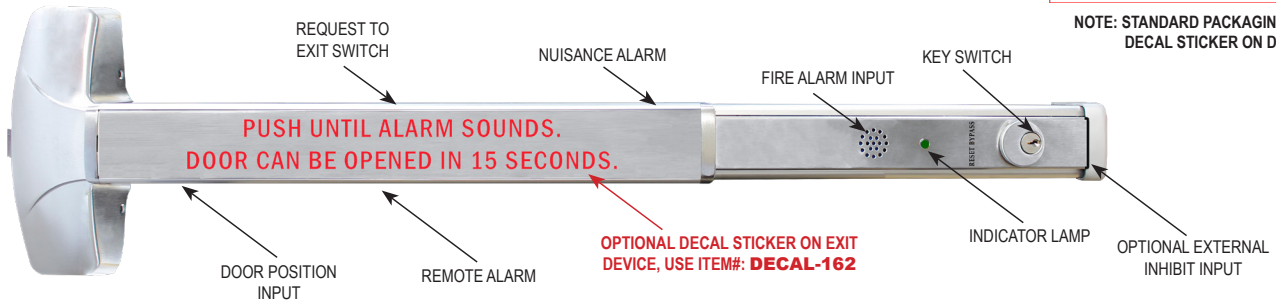

FEATURES		
EGRESS DELAY	BUILT-IN ANNUNCIATION	CODE COMPLIANCE
<ul style="list-style-type: none"> All in One Device 15 or 30 second exit delay (Factory set to 15 secs) 1 or 2 second nuisance delay Alarm and Lock reset 1 to 30 second momentary bypass Sustained bypass 	<ul style="list-style-type: none"> Armed mode Nuisance mode Irreversible egress mode Release mode <i>Optional External Inhibit Input</i> Remote override Remote reset 	<ul style="list-style-type: none"> IFC International Fire Code IBC International Building Code NFPA 101 Life Safety Code NFPA 1 Uniform Fire Code California Building Code Field selectable automatic or manual power up after emergency release or power loss
CONTROL INPUTS	TRIGGER MODES	MONITORING OUTPUTS
<ul style="list-style-type: none"> 1 to 30 second request-to-exit and bypass input with anti-tailgate and jumper selectable door prop alarm Reset 	<ul style="list-style-type: none"> Egress Alarm triggered by Push Bar Trigger input from external device field selectable (N/O or N/C) 	<ul style="list-style-type: none"> Armed mode Nuisance mode Release status

MUST ORDER CR602RF or CR631RF POWER SUPPLY TO HONOR WARRANTY AND UL MARKING

APPLICATION	
<p>When unauthorized egress is initiated the device delays egress through the door for 15 seconds (or 30 seconds). Meanwhile, the person exiting must wait while personnel or security responds. The door unlocks after 15 seconds have elapsed permitting egress. When powered by a fire control supervised power supply, the lock will release immediately in an emergency.</p>	<p>FOR USE WITH: (FIRE AND NON-FIRE)</p> <ul style="list-style-type: none"> A7700, AF7700 Rim Exit Devices A7760V, AF7760V Surface Vertical Rod Exit Device¹ N-77CVR, N-F77CVR Concealed Vertical Rod Exit Device N-MR7700, N-FMR7700 Mortise Lock Rim Exit Device GLS7700 Narrow Stile Rim Exit Device (on 36" Only) N-77GLS-CVR, N-F77GLS-CVR Narrow Stile Concealed Vertical Rod (on 36" Only) 77GLS-SVR, F77GLS-SVR Narrow Stile Surface Vertical Rod (on 36" Only) <p>¹Recommends use of rod and latch guards and strike monitor for surface vertical rods</p>

TECHNICAL SPECIFICATIONS	
<ul style="list-style-type: none"> 24V DC @ 430mA 24V DC @ 250mA Slave <p>Power Supply CR602RF 1 Amp / CR631RF 1.5 Amp</p>	<ul style="list-style-type: none"> Field selectable 12 or 24V DC, regulated and filtered Auto resetting output circuit protection Isolated 13.5 / 27V DC battery charger Low battery disconnect Emergency release input Field selectable UBC & California compliant manual power up Input, output and battery status LED's CR631RF - 16" x 14" x 6.5", CR602RF - 12" x 12" x 4" enclosure Choice of output and door control modules CR631RF - 1.5 Amp, CR602RF - 1.0 Amp Batteries not included
<p>CR631RF</p>	<p>CR602RF</p>

7700 Series Delayed Egress Models



GRADE 1 Delayed Egress All in One Exit Device

ANSI / BHMA A156.24 Delayed Egress Locking System Approved

For use in institutions, schools, universities, commercial buildings where heavy duty reliable operation is a requirement. 7700 Series Delayed Egress can also be used for fire exit hardware for all types of 4' x 8' single doors and 8' x 8' double doors for up to 3 hour fire labeled installations, it conforms to standards UL10C and UBC 7-2-1997 codes.



MEETS
The Buy American Act



5-YEAR WARRANTY



*Optional Decal sticker for the Exit Device, specify item# "DECAL-162" when ordering.



A7700, AF7700 Rim Panic Exit Devices

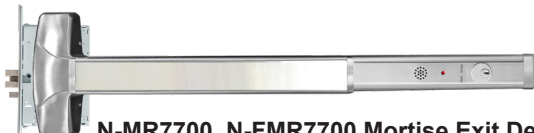

N-MR7700, N-FMR7700 Mortise Exit Devices

If a door position switch is not used, the outside trim will operate the door without affecting the armed setting of the device.



A7760V, AF7760V Surface Vertical Rod Exit Devices

To effectively use the surface vertical rod exit device, it is recommended that the rod and latch guards and monitor strike be used.



N-77GLS-CVR, N-F77GLS-CVR (36" ONLY) Narrow Stile Concealed Vertical Rod Exit Devices

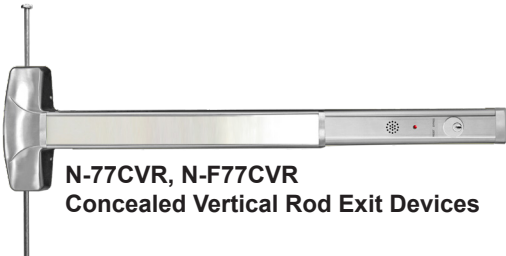

N-77CVR, N-F77CVR Concealed Vertical Rod Exit Devices



GLS7700 Narrow Stile Rim Exit Devices (36" ONLY)

77GLS-SVR, N-F77GLS-SVR (36" ONLY) Narrow Stile Surface Vertical Rod Exit Devices

DELAYED EGRESS OPTION IS AVAILABLE ON ALL 7700 SERIES EXIT DEVICES (GLS7700, N-77GLS-CVR & 77GLS-SVR Narrow Stile Exit Devices on 36" Only. Must use DEKIT48.)

♦♦ NOTE: DEKIT IS INSTALLED ON THE EXIT DEVICE UPON ORDERING. ♦♦

Must Specify: 7700 Series ITEM # and DEKIT36 (for 36") or DEKIT48 (for 48") separately.

for Example: A7700EO36 US32D with Delayed Egress option, ORDER: "A7700EO36 US32D" and "DEKIT36 US32D" as two line items.

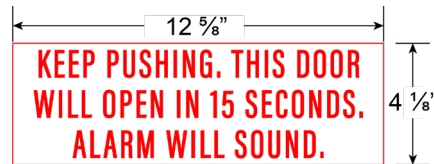
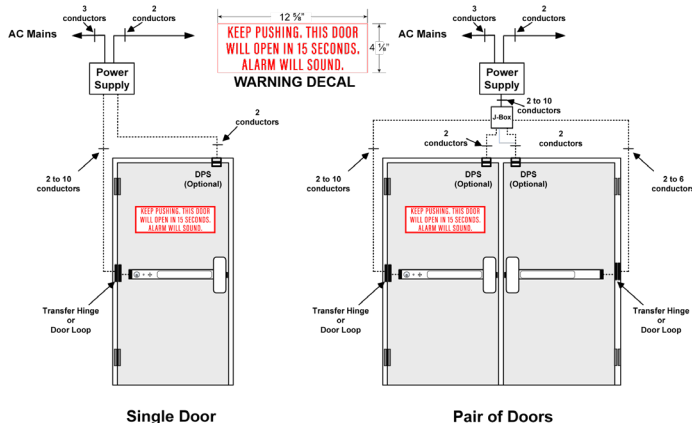

NOTE: STANDARD PACKAGING INCLUDES DECAL STICKER ON DOOR.

MUST ORDER CR602RF OR CR631RF POWER SUPPLY TO HONOR WARRANTY AND UL MARKING

Alarm Exit Hardware



Rim Type Exit Devices

- | | |
|--------------|---------------------------------------|
| NALRM770036 | Alarm Rim Type 36" Door (Panic Grade) |
| NALRM772048 | Alarm Rim Type 48" Door (Panic Grade) |
| FNALRM770036 | Alarm Rim Type 36" Door (Fire Grade) |
| FNALRM772048 | Alarm Rim Type 48" Door (Fire Grade) |

Vertical Rod Type Exit Devices

Prefix "NALRM" before PART #

Features

- 1, 3, 5-minute and continuous alarm type settings available
- ON and OFF power switch
- Alarm sound frequency is 120 db
- Alarm unit has internal horn. When the push rail is depressed, the horn sounds to provide an audible means of signaling that the door has been opened and breached.
- The key switch to turn alarm off is a standard 1 1/4" cylinder with "C" keyway. The alarm operates on one standard 9-volt transistor battery. When battery is weak the horn will emit an intermittent signal.
- Alarmed units are supplied with a micro switch, which monitors the push rail and the latch bolt for foolproof security on rim devices.
- Alarm unit has a signal OC output that can be linked to external alarm control systems.
- Unit includes "EMERGENCY EXIT ONLY • ALARM WILL SOUND" decal for application on door or unit.

Cylinder Dogging Kit

TO ORDER: Prefix "CD" before PART #. Available for all 7700 Series devices except fire exit hardware

KIT ONLY: use PART # 36CD7700 for 36" and 48CD7700 for 48" devices. Specify finish.

NOTE: Use PART # 48CD7700 for 36" GLS Narrow Stile Rim, CVR, and SVR Non-Fire Exit Devices



Finishes (Refer to Price List for Stock Finishes)

Cal-Royal	Description	BHMA	US Finish	Material
10B	Oil Rubbed Bronze	613	US10B	Bronze
32D	Satin Stainless	630	US32D	Stainless Steel

- (IC) INTERCHANGEABLE CORE: Interchangeable Core locks will accept compatible 6 or 7-Pin cores with BEST, FALCON and ARROW
- (ICSC) INTERCHANGEABLE CORE: Indicates function available with **Schlage Full Size Format** Interchangeable Core. Corbin, Sargent and Yale format also available.

(ELR) Electric Latch Retraction



Our motor driven electrified latch pullback exit device allows for remote keyless access control in high occupancy / high traffic conditions where exit devices are required. Common applications include conditions such as hospitals, airports, schools, churches and they are commonly specified in applications that require automatic door openers. The device may be continuously energized allowing for a push / pull condition if desired.

Features:

- Available on 7700 Series, including rim, vertical rod, concealed vertical rod, mortise exit device, fire and non fire-rated devices
- MM4S Smart Module: On board diagnostics with audible feedback for adjustment and power issues
- “PTS” (Push to Set Technology): 5 second electronic adjustment for easy post installation adjustment
- Electric dogging rated for continuous duty - Auto retraction if dogged push pad is pulled from position
- Low Current Draw - Field switchable to “High Torque” mode
- Up to 300’ wire run with (2) 18ga wire - Long wire runs provides installer with convenience of placing the locking device power supply in a centralized location; i.e. the same closet as the access panel
- 8’ cable with Quick Connect for MM4S module to easily connect to power supply lead
- 3-year “No Hassle” warranty

Specifications:

- Voltage – 22 to 28V DC
- System protection – unit shutdown when voltage exceeds 28V DC
- Average In-rush Current – 900mA; Average Hold Current - 215mA
- PTS adjustment – approx. ¼”
- Wire run: 300’ with 18ga wire

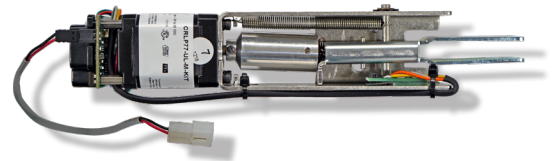

**INSTALLED ON THE EXIT
DEVICE: USE FLR7700 ADD**

**FOR FIELD INSTALLATION
USE FLR7700 KIT**

To Order:

- **Must Specify: Exit Device item #** and **FLR7700 ADD** as two separate line items.
For Example: A7700EO36 US32D with ELR option, order “**A7700EO36 US32D**”, and “**FLR7700 ADD**” as two line items.
- ***Use FLR7700 KIT if ordered separately.**
- **Optional Switch (RX or LX)** is also available and should be added as a **3rd line item** as needed.

Note: When using electrified hinge, you must use prefix ELELRn + hinge item code, where “n” is equal to number of wires. For example: ELELR4 + BB31.

MUST USE CRP POWER SUPPLIES TO HONOR WARRANTY (see pages 95-96)

Signal Switch RX and LX

RX (request to exit) signal switch is used to signal the use of an opening from the push side. When the push pad is depressed, the switch is activated. These devices are equipped with an internal SPDT (single pole double throw) switch that monitors the touch bar.

LX (latch bolt monitoring) signal switch monitors both egress and access of an opening. When the latch bolt is retracted, the switch is activated. These devices are equipped with an internal SPDT (single pole double throw) switch that monitors the latch bolt position.

LX and **RX** switches can be combined.

LX, RX switches can be used in combination with ELR (electric latch retraction) option.

Specifications

RX or **LX**.....Switch rated 0.5 amps @ 24V AC / DC resistive
Low current **RX** or **LX**.Switch rated 0.5 amps @ 24V AC / DC resistive

for Factory Installed. To Order, Specify:

- RX7700**.....Request to Exit switch for field installation
- LX7700**.....Latch bolt Monitoring switch for field installation
- LXR7700**.....Latch bolt Monitoring / Request to Exit Combination

Trim Selection

ESCUTCHEON LEVER DESIGN

CONSTRUCTION

- Free-wheeling clutch mechanism
- Grade 1, thru-bolted design
- Non-handed design
- Available for N-GLS-CVR, and GLS-SVR Type Exit Devices

DOOR THICKNESS

Standard 1 3/4". Extension Kit available for 2 1/4"- 6" thick doors.

ESCUTCHEON DIMENSIONS

1 13/16" width X 8 9/16" length

Lever length: 5"



GLSESC-00

⚙️ ICGLSESC-00

⚙️ ICSCGLSESC-00

ENTRANCE

Clutch free-wheeling Entrance, key locks or unlocks escutcheon trim ANSI Function (08). Operates as classroom function

GLSESC-05

⚙️ ICGLSESC-05

⚙️ ICSCGLSESC-05

STOREROOM

Clutch free-wheeling Storeroom, key unlocks lever, lever retracts latch bolt, otherwise always locked. ANSI Function (09)

GLSESC-30

PASSAGE

Trim always operable and free ANSI Function (14)

GLSESC-40

DUMMY

Dummy Escutcheon trim ANSI Function (02)

KEYWAY: 6-Pin solid brass "C" keyway Mortise Cylinder standard. Optional: Schlage E, Schlage C-K, Russwin D1-2-3-4, Corbin 59/60, Sargent LA-LB-LC, Falcon/Weiser E, Arrow A, Yale 8, Yale GA and Kwikset. Can also accept Medeco, Assa, Kaba and **Cal-Royal HSK** High Secity Cylinders.

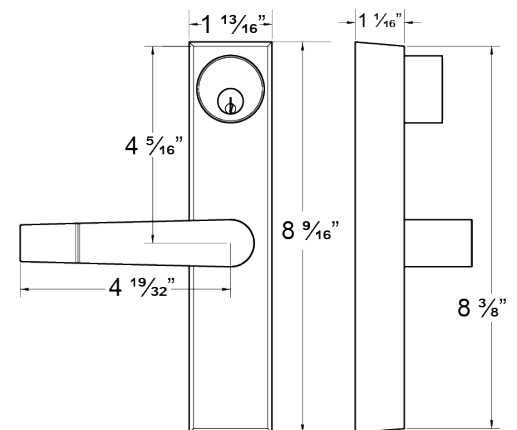

NOTES:

- AT, RL, TUB lever design is available upon request.
- **ELECTRIFICATION NOT AVAILABLE FOR TRIM**
- Electrical Latch Retraction (ELR) available for Exit Device only.
- Anti-Microbial Coating available in US26D Only. Use part # "**ANTB-TRIM**" when ordering.

⚙️ **(IC) INTERCHANGEABLE CORE:** Interchangeable Core locks will accept compatible 6 or 7-Pin cores with BEST, FALCON and ARROW

⚙️ **(ICSC) INTERCHANGEABLE CORE:** Indicates function available with **Schlage Full Size Format** Interchangeable Core. Corbin, Sargent and Yale format also available.

Trim Selection



PULL DESIGN - FOR GLS7700 RIM EXIT DEVICE ONLY

98GLSNL
IC98GLSNL
ICSC98GLSNL

Outside by pull and key.
 Key retracts latch bolt.
 ANSI Function (03)
(SPECIFY HANDING)

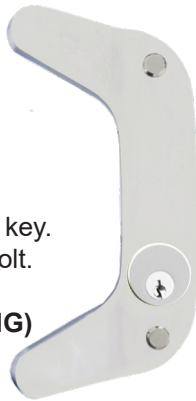

98GLSUP

Outside by pull only.
 Pull when dogged.
 ANSI Function (02)
(NON-HANDED)

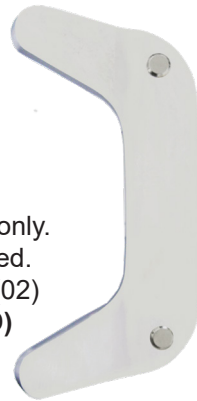

GLSRIMEOP

Outside cover plate
 only.
 ANSI Function (01)



KEYWAY

Standard 6-Pin solid brass "C"
 keyway Rim Cylinder included.

FINISHES

Architectural plated finishes.

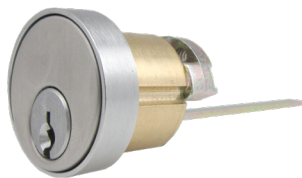
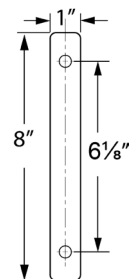
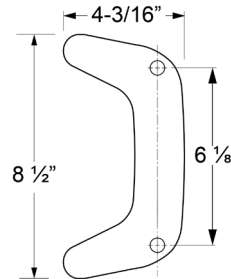
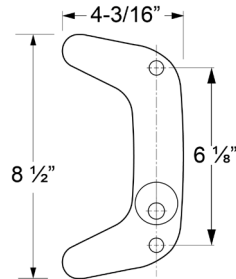

98GLSCYL-1



IC98GLSCYL-1
ICSC98GLSCYL-1



OFSTPUL-10
(REVERSIBLE)

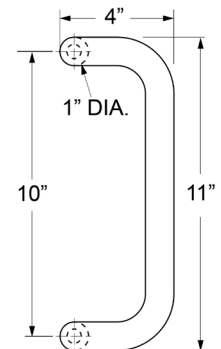

KEYWAY: 6-Pin solid brass "C" keyway Rim Cylinder standard. Optional: Schlage E, Schlage C-K, Russwin D1-2-3-4, Corbin 59/60, Sargent LA-LB-LC, Falcon/Weiser E, Arrow A, Yale 8, Yale GA and Kwikset. Can also accept Medeco, Assa, Kaba and **Cal-Royal HSK** High Security Cylinders.

- (IC) INTERCHANGEABLE CORE:** Interchangeable Core locks will accept compatible 6 or 7-Pin cores with BEST, FALCON and ARROW
- (ICSC) INTERCHANGEABLE CORE:** Indicates function available with **Schlage Full Size Format** Interchangeable Core. Corbin, Sargent and Yale format also available.