

(ELR) Electric Latch Retraction



Our motor driven electrified latch pullback exit device allows for remote keyless access control in high occupancy / high traffic conditions where exit devices are required. Common applications include conditions such as hospitals, airports, schools, churches and they are commonly specified in applications that require automatic door openers. The device may be continuously energized allowing for a push / pull condition if desired.

Features:

- Available on 9800 Series, including **Rim, Vertical Rod, Concealed Vertical Rod, Mortise Rim Type** fire and non fire-rated exit devices
- MM4 Smart Module: On board diagnostics with audible feedback for adjustment and power issues
- “PTS” (Push to Set Technology): 5 second electronic adjustment for easy post installation adjustment
- Electric dogging rated for continuous duty - Auto retraction if dogged push pad is pulled from position
- Low Current Draw - Field switchable to “High Torque” mode
- Up to 300’ wire run with (2) 18ga wire - Long wire runs provides installer with convenience of placing the locking device power supply in a centralized location; i.e. the same closet as the access panel
- 8’ cable with Quick Connect for MM4 module to easily connect to power supply lead
- 3-year “No Hassle” warranty

Specifications:

- Voltage – 24 to 28V DC
- System protection – unit shutdown when voltage exceeds 28V DC
- Average In-rush Current – 900mA; Average Hold Current - 215mA
- PTS adjustment – approx. ¼”
- Wire run: 300’ with 18ga wire

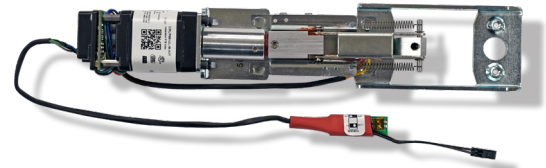

**INSTALLED ON THE EXIT
DEVICE: USE FLR2298 ADD**

**FOR FIELD INSTALLATION
USE FLR2298 KIT**

To Order:

- **Must Specify: Exit Device item #** and **FLR2298 ADD** as two separate line items.
For Example: A9800EO36 US32D with ELR option, order “**A9800EO36 US32D**”, and “**FLR2298 ADD**” as two line items.
- ***Use FLR2298 KIT if ordered separately.**
- **Optional Switch (RX or LX)** is also available and should be added as a **3rd line item** as needed.

Note: When using electrified hinge, you must use prefix ELELRn + hinge item code, where “n” is equal to number of wires. For example: ELELR4 + BB31.

**MUST USE CRP POWER SUPPLIES TO
HONOR WARRANTY (see pages 95-96)**

Signal Switch RX and LX

RX (request to exit) signal switch is used to signal the use of an opening from the push side. When the push pad is depressed, the switch is activated. These devices are equipped with an internal SPDT (single pole double throw) switch that monitors the touch bar.

LX (latch bolt monitoring) signal switch monitors both egress and access of an opening. When the latch bolt is retracted, the switch is activated. These devices are equipped with an internal SPDT (single pole double throw) switch that monitors the latch bolt position.

LX and **RX** switches can be combined.

LX, RX switches can be used in combination with ELR (electric latch retraction) option.

Specifications

RX or LX.....Switch rated 0.5 amps @ 24V AC / DC resistive
Low current **RX** or **LX**.Switch rated 0.5 amps @ 24V AC / DC resistive

for Factory Installed. To Order, Specify:

RX22/98.....Request to Exit switch for field installation
LX9800.....Latch bolt Monitoring switch for field installation
LXR9800.....Latch bolt Monitoring / Request to Exit Combination

Trim Selection

ESCUTCHEON LEVER DESIGN

CONSTRUCTION

- Free-wheeling clutch mechanism
- Grade 1, thru-bolted design
- Non-handed design
- Available for N-GLS-CVR, and GLS-SVR Type Exit Devices

DOOR THICKNESS

Standard 1 3/4". Extension Kit available for 2 1/4"- 6" thick doors.

ESCUTCHEON DIMENSIONS

1 13/16" width X 8 9/16" length

Lever length: 5"



GLSESC-00

⚙️ ICGLSESC-00

⚙️ ICSCGLSESC-00

ENTRANCE

Clutch free-wheeling Entrance, key locks or unlocks escutcheon trim ANSI Function (08). Operates as classroom function

GLSESC-05

⚙️ ICGLSESC-05

⚙️ ICSCGLSESC-05

STOREROOM

Clutch free-wheeling Storeroom, key unlocks lever, lever retracts latch bolt, otherwise always locked. ANSI Function (09)

GLSESC-30

PASSAGE

Trim always operable and free ANSI Function (14)

GLSESC-40

DUMMY

Dummy Escutcheon trim ANSI Function (02)

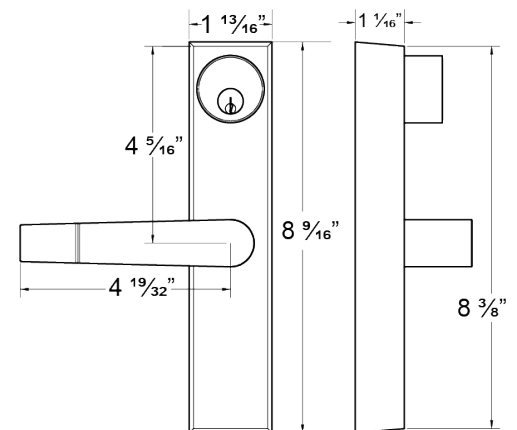

NOTES:

- AT, RL, TUB lever design is available upon request.
- **ELECTRIFICATION NOT AVAILABLE FOR TRIM**
- Electrical Latch Retraction (ELR) available for Exit Device only.
- Anti-Microbial Coating available in US26D Only. Use part # "**ANTB-TRIM**" when ordering.

KEYWAY: 6-Pin solid brass "C" keyway Mortise Cylinder standard. Optional: Schlage E, Schlage C-K, Russwin D1-2-3-4, Corbin 59/60, Sargent LA-LB-LC, Falcon/Weiser E, Arrow A, Yale 8, Yale GA and Kwikset. Can also accept Medeco, Assa, Kaba and **Cal-Royal HSK** High Secity Cylinders.

⚙️ **(IC) INTERCHANGEABLE CORE:** Interchangeable Core locks will accept compatible 6 or 7-Pin cores with BEST, FALCON and ARROW

⚙️ **(ICSC) INTERCHANGEABLE CORE:** Indicates function available with **Schlage Full Size Format** Interchangeable Core. Corbin, Sargent and Yale format also available.

Trim Selection



PULL DESIGN - FOR GLS9800 RIM EXIT DEVICE ONLY

98GLSNL
⌘ IC98GLSNL
⌘ ICSC98GLSNL

Outside by pull and key.
 Key retracts latch bolt.
 ANSI Function (03)
(SPECIFY HANDING)

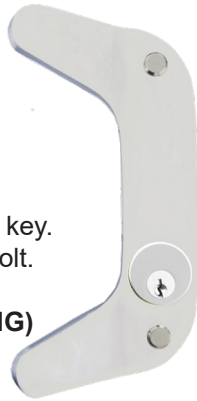

98GLSUP

Outside by pull only.
 Pull when dogged.
 ANSI Function (02)
(NON-HANDED)

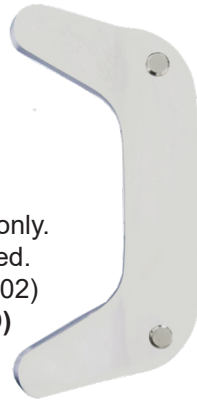

GLSRIMEOP

Outside cover plate
 only.
ANSI Function (01)



KEYWAY

Standard 6-Pin solid brass "C"
 keyway Rim Cylinder included.

FINISHES

Architectural plated finishes.

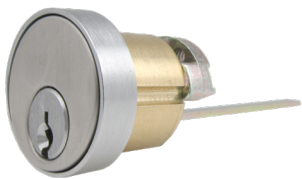
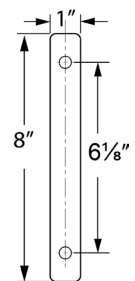
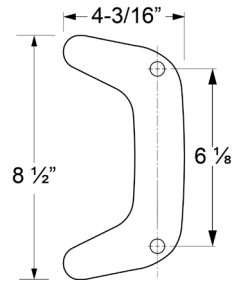
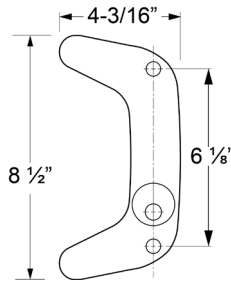

98GLSCYL-1



⌘ IC98GLSCYL-1
⌘ ICSC98GLSCYL-1



OFSTPUL-10
(REVERSIBLE)

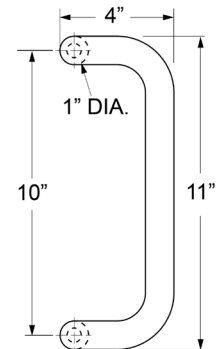

KEYWAY: 6-Pin solid brass "C" keyway Rim Cylinder standard. Optional: Schlage E, Schlage C-K, Russwin D1-2-3-4, Corbin 59/60, Sargent LA-LB-LC, Falcon/Weiser E, Arrow A, Yale 8, Yale GA and Kwikset. Can also accept Medeco, Assa, Kaba and **Cal-Royal HSK** High Security Cylinders.

⌘ (IC) INTERCHANGEABLE CORE: Interchangeable Core locks will accept compatible 6 or 7-Pin cores with BEST, FALCON and ARROW

⌘ (ICSC) INTERCHANGEABLE CORE: Indicates function available with **Schlage Full Size Format** Interchangeable Core. Corbin, Sargent and Yale format also available.

Strikes & Accessories

<p>Strike for A9800 Rim Type Exit Device</p> <p>239 For A9800 surface applied. Standard packaging.</p>	<p>Strike for AF9800 Rim Type Fire Exit Device</p> <p>245 For AF9800 surface applied. Standard packaging.</p>	
<p>ADA Roller Strike for A9800 and AF9800 Fire and Non-Fire Rim Exit Devices</p> <p>945 (NON-FIRE RATED) 945F (FIRE RATED)</p>	<p>Strikes for use with A9860V Vertical Rod Exit Device All strikes are black nylon coated</p> <p>221 Standard for A9860V. Applied to surface of floor or to a flat threshold. Standard packaging.</p> <p>227 Applied to surface of stop. No mortise required. Standard packaging.</p>	
<p>Strikes for use with AF9860V Vertical Rod Fire Exit Device</p> <p>245 For AF9860V surface applied. Standard packaging.</p> <p>233 Bottom stike. Alternate bottom strike. Flush mounting, stainless steel. Furnished with expansion shields. Requires mortise on the floor.</p>	<p>RIM238 Strike for 2 3/8" Backset Application</p>	<p>233 Bottom stike. Alternate bottom strike. Flush mounting, stainless steel. Furnished with expansion shields. Requires mortise on the floor.</p>
<p>Strikes for N-98GLS-CVR, N-F98GLS-CVR, 98GLS-SVR & F98GLS-SVR Fire and Non-Fire Exit Devices</p> <p>N-260 TOP STRIKE Dimensions: 2 1/32" top width, 37/64" top height, 1/8" top offset, 1 39/64" width, 1 7/32" height.</p> <p>N-265 BOTTOM STRIKE Dimensions: 51/64" top width, 11/16" top height, 1/8" top offset, 2 23/64" width, 29/32" height, 1 3/4" width.</p> <p>233 BOTTOM STRIKE Dimensions: 2-3/4" width, 1-13/16" height, 3/32" depth.</p> <p>N-221 BOTTOM STRIKE Dimensions: 1/4" top offset, 2" width, 13/32" height, 35/64" bottom offset.</p>	<p>Strikes for use with GLS9800 & FGSL9800 Narrow Stile Rim Type Fire and Non-Fire Exit Devices</p> <p>246 Used on frames with blade stop or integral stop. Surfaced applied or mortised. Standard packaging.</p> <p>247 Applied to surface of stop. No mortise required.</p>	

Strikes & Accessories



Strikes for 98-3PT & F98-3PT, Fire and Non-Fire Exit Devices

<p>610 Roller Rim Strike, surface applied. Standard Packaging.</p>	<p>620 Top Strike. Standard packaging.</p>	<p>221 Handicap Bottom Strike. Applied to surface of floor or to a flat threshold. Standard packaging.</p>	<p>233 Bottom strike. Flush mounting stainless steel. Furnished with expansion shields. Requires mortise in the floor.</p>
---	---	---	---

Overlapping Strike

Additional Accessories

<p>N251 Surface applied. Used on inactive leaf for device on active leaf of pair of doors without mullion.</p>	<p>LFF Lock front filler</p> <p>SF Strike filler</p>	<p>EXTROD66-12 12" Extension Rod for 98-3PT & F98-3PT Type</p> <p>EXTROD66-24 24" Extension Rod for 98-3PT & F98-3PT Type</p>
---	--	---

GLASS BEAD SHIM KITS

<p>801 – For Rim type, 1/8" thick 806 – For SVR type, 1/8" thick 812 – For fire rated SVR type, 1/8" thick</p>	<p>806-3 for 98-3PT type, 1/8" thick</p>	<p>812-3 for F98-3PT type, 1/8" thick</p>
---	---	--

CYLINDER DOGGING KITS

TO ORDER: Prefix "CD" before PART #.
Available for all 9800 Series Non-Fire Rated except Surface 3-PT Type
Exit Devices. Cylinder dogging with mortise cylinder is located on the
mounting insert lock bolt in retracted position.

KIT ONLY: Use PART # 36CD9800 for 36" and
48CD9800 for 48" devices. Specify finish.

NOTE: Use PART # 48CD9800 for 36" GLS Narrow Stile
Rim Type Non-Fire Exit Devices



CYLINDER DOGGING KIT

- (IC) INTERCHANGEABLE CORE:** Interchangeable Core locks will accept compatible 6 or 7-Pin cores with BEST, FALCON and ARROW
- (ICSC) INTERCHANGEABLE CORE:** Indicates function available with **Schlage Full Size Format** Interchangeable Core. Corbin, Sargent and Yale format also available.