

NM Series

HEAVY DUTY, GRADE 1 MORTISE LOCKSET

Optional Interchangeable Core Small Format (Best, Falcon and Arrow) or Large Format (Schlage)



LIFETIME WARRANTY

BHMA™ CERTIFIED
Be Safe. Be Secure. Look for the Mark.

MEETS
The Buy American Act

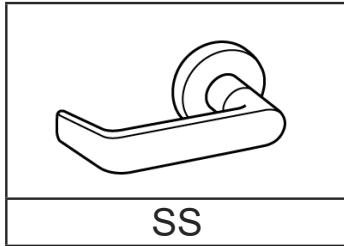

SS SECTIONAL TRIM ONLY

| FUNCTIONS | | ANSI | FINISHES | | | | |
|---|---|------|----------|-------|------|-------|----------------|
| <i>Single cylinder without deadbolt</i> | NM8050 - Office / Entrance | F04 | US26D | US32D | US32 | US10B | US3, 26, 4, 19 |
| | NM8056 - Office with Automatic Unlocking | ---- | | | | | |
| | NM8070 - Classroom | F05 | | | | | |
| | NM8080 - Storeroom | F07 | | | | | |
| <i>Single cylinder with deadbolt</i> | NM8453 - Entrance | F20 | | | | | |
| | NM8456 - Corridor | F13 | | | | | |
| | NM8495 - Keyed Privacy with Indicator | ---- | | | | | |
| | NM8465 - Closet / Storeroom with Deadbolt | ---- | | | | | |
| | NM8473 - Dormitory / Bedroom | F21 | | | | | |
| <i>Double cylinder without deadbolt</i> | NM8480 - Storeroom with Deadbolt | ---- | | | | | |
| | NM8071 - Classroom Security | F32 | | | | | |
| <i>Double cylinder with deadbolt</i> | NM8082 - Asylum / Institution | F30 | | | | | |
| | NM8457 - Classroom Security with Deadbolt | F33 | | | | | |
| | NM8458 - Classroom Security with Deadbolt and Auxiliary Latch | F34 | | | | | |
| <i>Other Functions</i> | NM8466 - Storeroom | F14 | | | | | |
| | NM8040 - Privacy Bedroom / Bath | F22 | | | | | |
| | NM8044 - Privacy with Coin Turn Outside | ---- | | | | | |
| | NM8440 - Privacy with Deadbolt | F19 | | | | | |
| | NM8444 - Privacy with Deadbolt & Coin Turn Outside | F19A | | | | | |
| | NM8445 - Privacy with Deadbolt, Coin Turn Outside and Indicator | F19B | | | | | |
| | NM8010 - Passage | F01 | | | | | |
| | NM8170 - Single Fixed Dummy | ---- | | | | | |
| | NM8172 - Double Fixed Dummy | ---- | | | | | |
| | NM8175 - Single Dummy with Lock Case | ---- | | | | | |
| NM8176 - Double Dummy with Lock Case | ---- | | | | | | |

Optional Interchangeable Cores All keyed lock functions are available with Best, Falcon and Arrow, Schlage, Corbin / Russwin, Sargent, and Yale Large Format Interchangeable Cores

NM Series

HEAVY DUTY, GRADE 1 MORTISE LOCKSET

88 Optional Interchangeable Core Small Format (Best, Falcon and Arrow) or Large Format (Schlage)

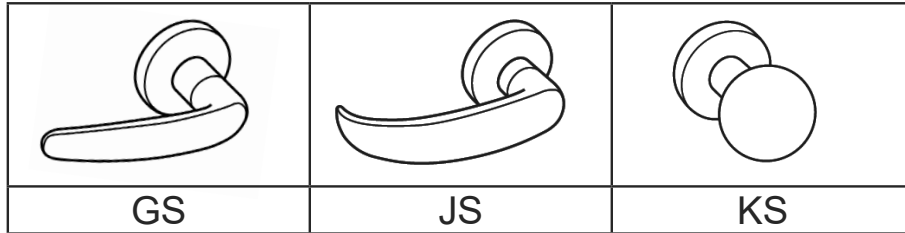

ALL ITEMS BELOW AVAILABLE WITH FACTORY LEAD TIME AND SUBJECT TO MINIMUM ORDER QUANTITY

GS, JS, AND KS SECTIONAL TRIM ONLY

| FUNCTIONS | | ANSI | FINISHES | | | |
|---|---|------|----------|-------|------|---------------------|
| <i>Single cylinder without deadbolt</i> | NM8050 - Office / Entrance | F04 | US26D | US32D | US32 | US10B, 3, 26, 4, 19 |
| | NM8056 - Office with Automatic Unlocking | ---- | | | | |
| | NM8070 - Classroom | F05 | | | | |
| | NM8080 - Storeroom | F07 | | | | |
| <i>Single cylinder with deadbolt</i> | NM8453 - Entrance | F20 | | | | |
| | NM8456 - Corridor | F13 | | | | |
| | NM8495 - Keyed Privacy with Indicator | ---- | | | | |
| | NM8465 - Closet / Storeroom with Deadbolt | ---- | | | | |
| | NM8473 - Dormitory / Bedroom | F21 | | | | |
| <i>Double cylinder without deadbolt</i> | NM8480 - Storeroom with Deadbolt | ---- | | | | |
| | NM8071 - Classroom Security | F32 | | | | |
| <i>Double cylinder with deadbolt</i> | NM8082 - Asylum / Institution | F30 | | | | |
| | NM8457 - Classroom Security with Deadbolt | F33 | | | | |
| | NM8458 - Classroom Security with Deadbolt and Auxiliary Latch | F34 | | | | |
| <i>Other Functions</i> | NM8466 - Storeroom | F14 | | | | |
| | NM8040 - Privacy Bedroom / Bath | F22 | | | | |
| | NM8044 - Privacy with Coin Turn Outside | ---- | | | | |
| | NM8440 - Privacy with Deadbolt | F19 | | | | |
| | NM8444 - Privacy with Deadbolt & Coin Turn Outside | F19A | | | | |
| | NM8445 - Privacy with Deadbolt, Coin Turn Outside and Indicator | F19B | | | | |
| | NM8010 - Passage | F01 | | | | |
| | NM8170 - Single Fixed Dummy | ---- | | | | |
| | NM8172 - Double Fixed Dummy | ---- | | | | |
| | NM8175 - Single Dummy with Lock Case | ---- | | | | |
| NM8176 - Double Dummy with Lock Case | ---- | | | | | |

88 All keyed lock functions are available with Best, Falcon and Arrow, Schlage, Corbin / Russwin, Sargent, and Yale Large Format Interchangeable Cores

NM Series

HEAVY DUTY, GRADE 1 MORTISE LOCKSET

•• Optional Interchangeable Core Small Format (Best, Falcon and Arrow) or Large Format (Schlage)

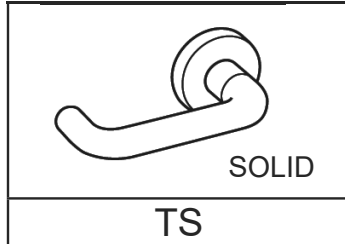

| TS SECTIONAL TRIM ONLY | | | | | | |
|---|---|------|----------|-------|------|---------------------|
| FUNCTIONS | | ANSI | FINISHES | | | |
| <i>Single cylinder without deadbolt</i> | NM8050 - Office / Entrance | F04 | US26D | US32D | US32 | US10B, 3, 26, 4, 19 |
| | NM8056 - Office with Automatic Unlocking | ---- | | | | |
| | NM8070 - Classroom | F05 | | | | |
| | NM8080 - Storeroom | F07 | | | | |
| <i>Single cylinder with deadbolt</i> | NM8453 - Entrance | F20 | | | | |
| | NM8456 - Corridor | F13 | | | | |
| | NM8495 - Keyed Privacy with Indicator | ---- | | | | |
| | NM8465 - Closet / Storeroom with Deadbolt | ---- | | | | |
| | NM8473 - Dormitory / Bedroom | F21 | | | | |
| <i>Double cylinder without deadbolt</i> | NM8480 - Storeroom with Deadbolt | ---- | | | | |
| | NM8071 - Classroom Security | F32 | | | | |
| <i>Double cylinder with deadbolt</i> | NM8082 - Asylum / Institution | F30 | | | | |
| | NM8457 - Classroom Security with Deadbolt | F33 | | | | |
| | NM8458 - Classroom Security with Deadbolt and Auxiliary Latch | F34 | | | | |
| <i>Other Functions</i> | NM8466 - Storeroom | F14 | | | | |
| | NM8040 - Privacy Bedroom / Bath | F22 | | | | |
| | NM8044 - Privacy with Coin Turn Outside | ---- | | | | |
| | NM8440 - Privacy with Deadbolt | F19 | | | | |
| | NM8444 - Privacy with Deadbolt & Coin Turn Outside | F19A | | | | |
| | NM8445 - Privacy with Deadbolt, Coin Turn Outside and Indicator | F19B | | | | |
| | NM8010 - Passage | F01 | | | | |
| | NM8170 - Single Fixed Dummy | ---- | | | | |
| | NM8172 - Double Fixed Dummy | ---- | | | | |
| | NM8175 - Single Dummy with Lock Case | ---- | | | | |
| NM8176 - Double Dummy with Lock Case | ---- | | | | | |

•• All keyed lock functions are available with Best, Falcon and Arrow, Schlage, Corbin / Russwin, Sargent, and Yale Large Format Interchangeable Cores

NM Series

HEAVY DUTY, GRADE 1 MORTISE LOCKSET

Optional Interchangeable Core Small Format (Best, Falcon and Arrow) or Large Format (Schlage)



SECTIONAL TRIMS

| | | | |
|----------------------------------|----------------------------------|------------------|------------------|
| <p>(HOLLOW)</p> <p>CS</p> | <p>(HOLLOW)</p> <p>HS</p> | <p>VS</p> | <p>YS</p> |
| <p>FS</p> | <p>IS</p> | <p>DS</p> | <p>MS</p> |
| <p>QS</p> | <p>ZS</p> | <p>RS</p> | <p>PS</p> |
| <p>WS</p> | <p>XS</p> | | |

NM Series

HEAVY DUTY, GRADE 1 MORTISE LOCKSET

Optional Interchangeable Core Small Format (Best, Falcon and Arrow) or Large Format (Schlage)

NON-STOCK ITEMS
ALL ITEMS BELOW AVAILABLE WITH FACTORY LEAD TIME
AND SUBJECT TO MINIMUM ORDER QUANTITY

CS, HS, VS, YS, DS, FS, IS, MS, QS, RS, PS, WS, XS, ZS
SECTIONAL TRIM ONLY

| FUNCTIONS | | ANSI | FINISHES | | |
|---|---|------|----------|-----------|---------------------|
| <i>Single cylinder without deadbolt</i> | NM8050 - Office / Entrance | F04 | US26D | US32D, 32 | US10B, 3, 26, 4, 19 |
| | NM8056 - Office with Automatic Unlocking | ---- | | | |
| | NM8070 - Classroom | F05 | | | |
| | NM8080 - Storeroom | F07 | | | |
| <i>Single cylinder with deadbolt</i> | NM8453 - Entrance | F20 | | | |
| | NM8456 - Corridor | F13 | | | |
| | NM8495 - Keyed Privacy with Indicator | ---- | | | |
| | NM8465 - Closet / Storeroom with Deadbolt | ---- | | | |
| | NM8473 - Dormitory / Bedroom | F21 | | | |
| <i>Double cylinder without deadbolt</i> | NM8480 - Storeroom with Deadbolt | ---- | | | |
| | NM8071 - Classroom Security | F32 | | | |
| <i>Double cylinder with deadbolt</i> | NM8082 - Asylum / Institution | F30 | | | |
| | NM8457 - Classroom Security with Deadbolt | F33 | | | |
| | NM8458 - Classroom Security with Deadbolt and Auxiliary Latch | F34 | | | |
| <i>Other Functions</i> | NM8466 - Storeroom | F14 | | | |
| | NM8040 - Privacy Bedroom / Bath | F22 | | | |
| | NM8044 - Privacy with Coin Turn Outside | ---- | | | |
| | NM8440 - Privacy with Deadbolt | F19 | | | |
| | NM8444 - Privacy with Deadbolt & Coin Turn Outside | F19A | | | |
| | NM8445 - Privacy with Deadbolt, Coin Turn Outside and Indicator | F19B | | | |
| | NM8010 - Passage | F01 | | | |
| | NM8170 - Single Fixed Dummy | ---- | | | |
| | NM8172 - Double Fixed Dummy | ---- | | | |
| | NM8175 - Single Dummy with Lock Case | ---- | | | |
| NM8176 - Double Dummy with Lock Case | ---- | | | | |

Optional Interchangeable Cores All keyed lock functions are available with **Best, Falcon and Arrow, Schlage, Corbin / Russwin, Sargent, and Yale Large Format Interchangeable Cores**

NM Series

HEAVY DUTY, GRADE 1 MORTISE LOCKSET

•• Optional Interchangeable Core Small Format (Best, Falcon and Arrow) or Large Format (Schlage)

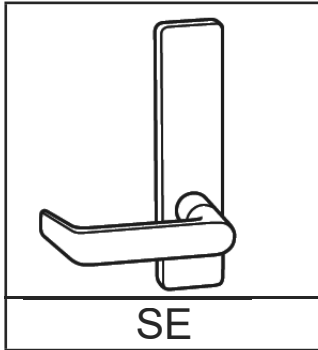

**NON-STOCK FINISHES AVAILABLE
WITH FACTORY LEAD TIME AND
SUBJECT TO MINIMUM ORDER**

| SE ESCUTCHEON TRIM ONLY | | | | | | | |
|---|---|------|----------|-------|-------|---------|---------|
| FUNCTIONS | | ANSI | FINISHES | | | | |
| <i>Single cylinder without deadbolt</i> | NM8050 - Office / Entrance | F04 | US26D | US32D | US10B | US3, 26 | US4, 19 |
| | NM8056 - Office with Automatic Unlocking | ---- | | | | | |
| | NM8070 - Classroom | F05 | | | | | |
| | NM8080 - Storeroom | F07 | | | | | |
| <i>Single cylinder with deadbolt</i> | NM8453 - Entrance | F20 | | | | | |
| | NM8456 - Corridor | F13 | | | | | |
| | NM8495 - Keyed Privacy with Indicator | ---- | | | | | |
| | NM8465 - Closet / Storeroom with Deadbolt | ---- | | | | | |
| | NM8473 - Dormitory / Bedroom | F21 | | | | | |
| <i>Double cylinder without deadbolt</i> | NM8480 - Storeroom with Deadbolt | ---- | | | | | |
| | NM8071 - Classroom Security | F32 | | | | | |
| <i>Double cylinder with deadbolt</i> | NM8082 - Asylum / Institution | F30 | | | | | |
| | NM8457 - Classroom Security with Deadbolt | F33 | | | | | |
| | NM8458 - Classroom Security with Deadbolt and Auxiliary Latch | F34 | | | | | |
| <i>Other Functions</i> | NM8466 - Storeroom | F14 | | | | | |
| | NM8040 - Privacy Bedroom / Bath | F22 | | | | | |
| | NM8044 - Privacy with Coin Turn Outside | ---- | | | | | |
| | NM8440 - Privacy with Deadbolt | F19 | | | | | |
| | NM8444 - Privacy with Deadbolt & Coin Turn Outside | F19A | | | | | |
| | NM8445 - Privacy with Deadbolt, Coin Turn Outside and Indicator | F19B | | | | | |
| | NM8010 - Passage | F01 | | | | | |
| | NM8170 - Single Fixed Dummy | ---- | | | | | |
| | NM8172 - Double Fixed Dummy | ---- | | | | | |
| | NM8175 - Single Dummy with Lock Case | ---- | | | | | |
| NM8176 - Double Dummy with Lock Case | ---- | | | | | | |

•• All keyed lock functions are available with Best, Falcon and Arrow, Schlage, Corbin / Russwin, Sargent, and Yale Large Format Interchangeable Cores

NM Series

HEAVY DUTY, GRADE 1 MORTISE LOCKSET

Optional Interchangeable Core Small Format (Best, Falcon and Arrow) or Large Format (Schlage)

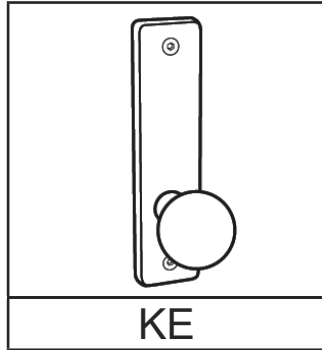

**NON-STOCK FINISHES AVAILABLE
WITH FACTORY LEAD TIME AND
SUBJECT TO MINIMUM ORDER**

| KE ESCUTCHEON TRIM ONLY | | | | | |
|---|---|------|----------|-------|---------------------|
| FUNCTIONS | | ANSI | FINISHES | | |
| <i>Single cylinder without deadbolt</i> | NM8050 - Office / Entrance | F04 | US26D | US32D | US10B, 3, 26, 4, 19 |
| | NM8056 - Office with Automatic Unlocking | ---- | | | |
| | NM8070 - Classroom | F05 | | | |
| | NM8080 - Storeroom | F07 | | | |
| <i>Single cylinder with deadbolt</i> | NM8453 - Entrance | F20 | | | |
| | NM8456 - Corridor | F13 | | | |
| | NM8495 - Keyed Privacy with Indicator | ---- | | | |
| | NM8465 - Closet / Storeroom with Deadbolt | ---- | | | |
| | NM8473 - Dormitory / Bedroom | F21 | | | |
| | NM8480 - Storeroom with Deadbolt | ---- | | | |
| <i>Double cylinder without deadbolt</i> | NM8071 - Classroom Security | F32 | | | |
| | NM8082 - Asylum / Institution | F30 | | | |
| <i>Double cylinder with deadbolt</i> | NM8457 - Classroom Security with Deadbolt | F33 | | | |
| | NM8458 - Classroom Security with Deadbolt and Auxiliary Latch | F34 | | | |
| | NM8466 - Storeroom | F14 | | | |
| <i>Other Functions</i> | NM8040 - Privacy Bedroom / Bath | F22 | | | |
| | NM8044 - Privacy with Coin Turn Outside | ---- | | | |
| | NM8440 - Privacy with Deadbolt | F19 | | | |
| | NM8444 - Privacy with Deadbolt & Coin Turn Outside | F19A | | | |
| | NM8445 - Privacy with Deadbolt, Coin Turn Outside and Indicator | F19B | | | |
| | NM8010 - Passage | F01 | | | |
| | NM8170 - Single Fixed Dummy | ---- | | | |
| | NM8172 - Double Fixed Dummy | ---- | | | |
| | NM8175 - Single Dummy with Lock Case | ---- | | | |
| | NM8176 - Double Dummy with Lock Case | ---- | | | |

Optional Interchangeable Cores All keyed lock functions are available with Best, Falcon and Arrow, Schlage, Corbin / Russwin, Sargent, and Yale Large Format Interchangeable Cores

NM Series

HEAVY DUTY, GRADE 1 MORTISE LOCKSET

•• Optional Interchangeable Core Small Format (Best, Falcon and Arrow) or Large Format (Schlage)

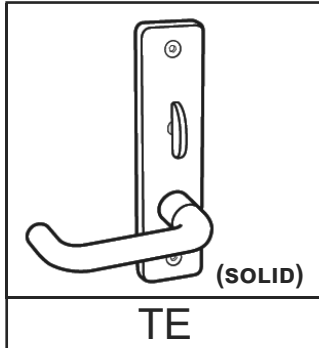

**NON-STOCK FINISHES AVAILABLE
WITH FACTORY LEAD TIME AND
SUBJECT TO MINIMUM ORDER**

| TE ESCUTCHEON TRIM ONLY | | | | | |
|---|---|------|----------|-------|---------------------|
| FUNCTIONS | | ANSI | FINISHES | | |
| <i>Single cylinder without deadbolt</i> | NM8050 - Office / Entrance | F04 | US26D | US32D | US10B, 3, 26, 4, 19 |
| | NM8056 - Office with Automatic Unlocking | ---- | | | |
| | NM8070 - Classroom | F05 | | | |
| | NM8080 - Storeroom | F07 | | | |
| <i>Single cylinder with deadbolt</i> | NM8453 - Entrance | F20 | | | |
| | NM8456 - Corridor | F13 | | | |
| | NM8495 - Keyed Privacy with Indicator | ---- | | | |
| | NM8465 - Closet / Storeroom with Deadbolt | ---- | | | |
| | NM8473 - Dormitory / Bedroom | F21 | | | |
| | NM8480 - Storeroom with Deadbolt | ---- | | | |
| <i>Double cylinder without deadbolt</i> | NM8071 - Classroom Security | F32 | | | |
| | NM8082 - Asylum / Institution | F30 | | | |
| <i>Double cylinder with deadbolt</i> | NM8457 - Classroom Security with Deadbolt | F33 | | | |
| | NM8458 - Classroom Security with Deadbolt and Auxiliary Latch | F34 | | | |
| | NM8466 - Storeroom | F14 | | | |
| <i>Other Functions</i> | NM8040 - Privacy Bedroom / Bath | F22 | | | |
| | NM8044 - Privacy with Coin Turn Outside | ---- | | | |
| | NM8440 - Privacy with Deadbolt | F19 | | | |
| | NM8444 - Privacy with Deadbolt & Coin Turn Outside | F19A | | | |
| | NM8445 - Privacy with Deadbolt, Coin Turn Outside and Indicator | F19B | | | |
| | NM8010 - Passage | F01 | | | |
| | NM8170 - Single Fixed Dummy | ---- | | | |
| | NM8172 - Double Fixed Dummy | ---- | | | |
| | NM8175 - Single Dummy with Lock Case | ---- | | | |
| | NM8176 - Double Dummy with Lock Case | ---- | | | |

•• All keyed lock functions are available with Best, Falcon and Arrow, Schlage, Corbin / Russwin, Sargent, and Yale Large Format Interchangeable Cores

NM Series

HEAVY DUTY, GRADE 1 MORTISE LOCKSET

Optional Interchangeable Core Small Format (Best, Falcon and Arrow) or Large Format (Schlage)

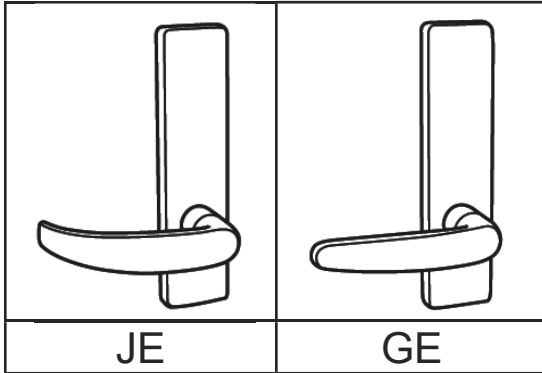

**NON-STOCK FINISHES AVAILABLE
WITH FACTORY LEAD TIME AND
SUBJECT TO MINIMUM ORDER**

| JE AND GE ESCUTCHEON TRIM ONLY | | | | | |
|---|---|------|----------|-------|---------------------|
| FUNCTIONS | | ANSI | FINISHES | | |
| <i>Single cylinder without deadbolt</i> | NM8050 - Office / Entrance | F04 | US26D | US32D | US10B, 3, 26, 4, 19 |
| | NM8056 - Office with Automatic Unlocking | ---- | | | |
| | NM8070 - Classroom | F05 | | | |
| | NM8080 - Storeroom | F07 | | | |
| <i>Single cylinder with deadbolt</i> | NM8453 - Entrance | F20 | | | |
| | NM8456 - Corridor | F13 | | | |
| | NM8495 - Keyed Privacy with Indicator | ---- | | | |
| | NM8465 - Closet / Storeroom with Deadbolt | ---- | | | |
| | NM8473 - Dormitory / Bedroom | F21 | | | |
| <i>Double cylinder without deadbolt</i> | NM8480 - Storeroom with Deadbolt | ---- | | | |
| | NM8071 - Classroom Security | F32 | | | |
| <i>Double cylinder with deadbolt</i> | NM8082 - Asylum / Institution | F30 | | | |
| | NM8457 - Classroom Security with Deadbolt | F33 | | | |
| | NM8458 - Classroom Security with Deadbolt and Auxiliary Latch | F34 | | | |
| <i>Other Functions</i> | NM8466 - Storeroom | F14 | | | |
| | NM8040 - Privacy Bedroom / Bath | F22 | | | |
| | NM8044 - Privacy with Coin Turn Outside | ---- | | | |
| | NM8440 - Privacy with Deadbolt | F19 | | | |
| | NM8444 - Privacy with Deadbolt & Coin Turn Outside | F19A | | | |
| | NM8445 - Privacy with Deadbolt, Coin Turn Outside and Indicator | F19B | | | |
| | NM8010 - Passage | F01 | | | |
| | NM8170 - Single Fixed Dummy | ---- | | | |
| | NM8172 - Double Fixed Dummy | ---- | | | |
| | NM8175 - Single Dummy with Lock Case | ---- | | | |
| NM8176 - Double Dummy with Lock Case | ---- | | | | |

Optional Interchangeable Cores All keyed lock functions are available with Best, Falcon and Arrow, Schlage, Corbin / Russwin, Sargent, and Yale Large Format Interchangeable Cores

NM Series

HEAVY DUTY, GRADE 1 MORTISE LOCKSET

Optional Interchangeable Core Small Format (Best, Falcon and Arrow) or Large Format (Schlage)

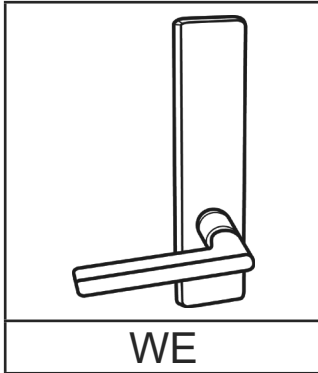

**NON-STOCK FINISHES AVAILABLE
WITH FACTORY LEAD TIME AND
SUBJECT TO MINIMUM ORDER**

| WE ESCUTCHEON TRIM ONLY | | | | | | | |
|---|---|------|----------|------|-------|-----------------|--|
| FUNCTIONS | | ANSI | FINISHES | | | | |
| <i>Single cylinder without deadbolt</i> | NM8050 - Office / Entrance | F04 | US26D | US19 | US32D | US10B, 3, 26, 4 | |
| | NM8056 - Office with Automatic Unlocking | ---- | | | | | |
| | NM8070 - Classroom | F05 | | | | | |
| | NM8080 - Storeroom | F07 | | | | | |
| <i>Single cylinder with deadbolt</i> | NM8453 - Entrance | F20 | | | | | |
| | NM8456 - Corridor | F13 | | | | | |
| | NM8495 - Keyed Privacy with Indicator | ---- | | | | | |
| | NM8465 - Closet / Storeroom with Deadbolt | ---- | | | | | |
| | NM8473 - Dormitory / Bedroom | F21 | | | | | |
| <i>Double cylinder without deadbolt</i> | NM8480 - Storeroom with Deadbolt | ---- | | | | | |
| | NM8071 - Classroom Security | F32 | | | | | |
| <i>Double cylinder with deadbolt</i> | NM8082 - Asylum / Institution | F30 | | | | | |
| | NM8457 - Classroom Security with Deadbolt | F33 | | | | | |
| | NM8458 - Classroom Security with Deadbolt and Auxiliary Latch | F34 | | | | | |
| <i>Other Functions</i> | NM8466 - Storeroom | F14 | | | | | |
| | NM8040 - Privacy Bedroom / Bath | F22 | | | | | |
| | NM8044 - Privacy with Coin Turn Outside | ---- | | | | | |
| | NM8440 - Privacy with Deadbolt | F19 | | | | | |
| | NM8444 - Privacy with Deadbolt & Coin Turn Outside | F19A | | | | | |
| | NM8445 - Privacy with Deadbolt, Coin Turn Outside and Indicator | F19B | | | | | |
| | NM8010 - Passage | F01 | | | | | |
| | NM8170 - Single Fixed Dummy | ---- | | | | | |
| | NM8172 - Double Fixed Dummy | ---- | | | | | |
| | NM8175 - Single Dummy with Lock Case | ---- | | | | | |
| NM8176 - Double Dummy with Lock Case | ---- | | | | | | |













Optional Interchangeable Cores All keyed lock functions are available with **Best, Falcon and Arrow, Schlage, Corbin / Russwin, Sargent, and Yale Large Format Interchangeable Cores**

NM Series

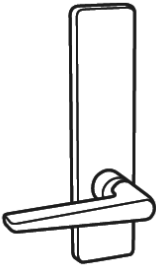
HEAVY DUTY, GRADE 1 MORTISE LOCKSET

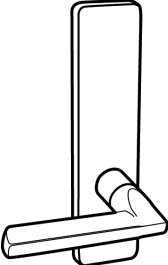
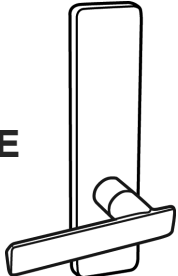
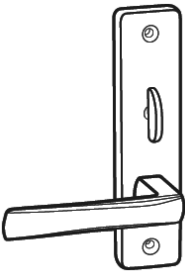
Optional Interchangeable Core Small Format (Best, Falcon and Arrow) or Large Format (Schlage)

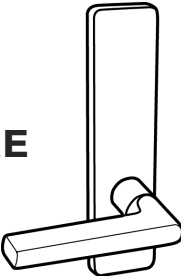
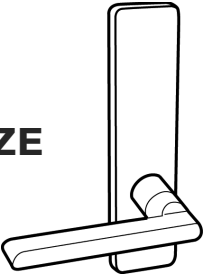
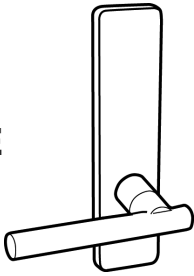
ESCUTCHEON TRIMS

| | | | | |
|---|--|---|--|--|
| <p>(HOLLOW)</p> <p>CE</p>  |     | | | |
| <p>(HOLLOW)</p> <p>HE</p>  | <p>VE</p>  | <p>YE</p>  | <p>FE</p>  | |
| <p>IE</p>  | <p>DE</p>  | <p>ME</p>  | <p>QE</p>  | |
| <p>ZE</p>  | <p>RE</p>  | <p>PE</p>  | <p>XE</p>  | |

| | |
|--|---|
| <p>HURRICANE APPROVED HARDWARE FLORIDA BUILDING CODE FL13922-R8 ASTM E330-02 & E1886-05/1996-06 TAS 201, 202, 203-94 UL10C-09</p> | <p>HURRICANE APPROVED HARDWARE TEXAS EVALUATION ID DR-472 ASTM E330-14/ E1886-13a/ E1996-14a</p> |
|--|---|

NM Series

HEAVY DUTY, GRADE 1 MORTISE LOCKSET

•• Optional Interchangeable Core Small Format (Best, Falcon and Arrow) or Large Format (Schlage)

NON-STOCK ITEMS
ALL ITEMS BELOW AVAILABLE WITH FACTORY LEAD TIME
AND SUBJECT TO MINIMUM ORDER QUANTITY

**CE, HE, VE, YE, FE, IE, DE, ME, QE, ZE, RE, PE, XE
ESCUTCHEON TRIM ONLY**

| FUNCTIONS | | ANSI | FINISHES | | |
|---|---|------|----------|-------|---------------------|
| <i>Single cylinder without deadbolt</i> | NM8050 - Office / Entrance | F04 | US26D | US32D | US10B, 3, 26, 4, 19 |
| | NM8056 - Office with Automatic Unlocking | ---- | | | |
| | NM8070 - Classroom | F05 | | | |
| | NM8080 - Storeroom | F07 | | | |
| <i>Single cylinder with deadbolt</i> | NM8453 - Entrance | F20 | | | |
| | NM8456 - Corridor | F13 | | | |
| | NM8495 - Keyed Privacy with Indicator | ---- | | | |
| | NM8465 - Closet / Storeroom with Deadbolt | ---- | | | |
| | NM8473 - Dormitory / Bedroom | F21 | | | |
| <i>Double cylinder without deadbolt</i> | NM8480 - Storeroom with Deadbolt | ---- | | | |
| | NM8071 - Classroom Security | F32 | | | |
| <i>Double cylinder with deadbolt</i> | NM8082 - Asylum / Institution | F30 | | | |
| | NM8457 - Classroom Security with Deadbolt | F33 | | | |
| <i>Double cylinder with deadbolt</i> | NM8458 - Classroom Security with Deadbolt and Auxiliary Latch | F34 | | | |
| | NM8466 - Storeroom | F14 | | | |
| <i>Other Functions</i> | NM8040 - Privacy Bedroom / Bath | F22 | | | |
| | NM8044 - Privacy with Coin Turn Outside | ---- | | | |
| | NM8440 - Privacy with Deadbolt | F19 | | | |
| | NM8444 - Privacy with Deadbolt & Coin Turn Outside | F19A | | | |
| | NM8445 - Privacy with Deadbolt, Coin Turn Outside and Indicator | F19B | | | |
| | NM8010 - Passage | F01 | | | |
| | NM8170 - Single Fixed Dummy | ---- | | | |
| | NM8172 - Double Fixed Dummy | ---- | | | |
| | NM8175 - Single Dummy with Lock Case | ---- | | | |
| NM8176 - Double Dummy with Lock Case | ---- | | | | |

•• All keyed lock functions are available with Best, Falcon and Arrow, Schlage, Corbin / Russwin, Sargent, and Yale Large Format Interchangeable Cores

WI Series

HEAVY DUTY, GRADE 1 WIDE ESCUTCHEON MORTISE LOCKSET

Optional Interchangeable Core Small Format (Best, Falcon and Arrow) or Large Format (Schlage)

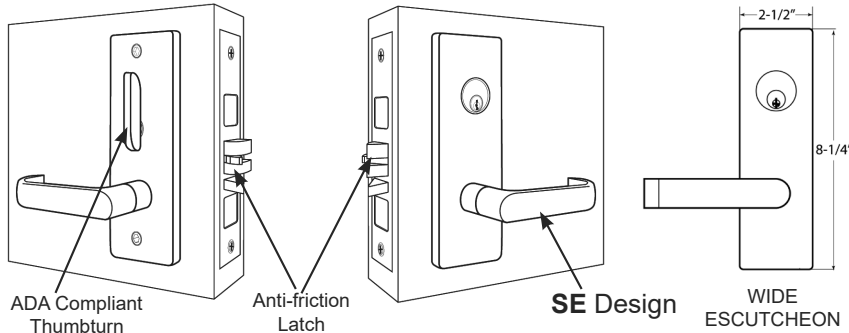

NON-STOCK FINISHES AVAILABLE WITH FACTORY LEAD TIME AND SUBJECT TO MINIMUM ORDER

WIDE ESCUTCHEON SE TRIM ONLY



| FUNCTIONS | | ANSI | FINISHES | |
|---|---|------|----------|---------------------|
| <i>Single cylinder without deadbolt</i> | WI8050 - Office / Entrance | F04 | US26D | US10B, 3, 26, 4, 19 |
| | WI8056 - Office with Automatic Unlocking | ---- | | |
| | WI8070 - Classroom | F05 | | |
| | WI8080 - Storeroom | F07 | | |
| <i>Single cylinder with deadbolt</i> | WI8453 - Entrance | F20 | | |
| | WI8456 - Corridor | F13 | | |
| | WI8495 - Keyed Privacy with Indicator | ---- | | |
| | WI8465 - Closet / Storeroom with Deadbolt | ---- | | |
| | WI8473 - Dormitory / Bedroom | F21 | | |
| <i>Double cylinder without deadbolt</i> | WI8480 - Storeroom with Deadbolt | ---- | | |
| | WI8071 - Classroom Security | F32 | | |
| <i>Double cylinder with deadbolt</i> | WI8082 - Asylum / Institution | F30 | | |
| | WI8457 - Classroom Security with Deadbolt | F33 | | |
| | WI8458 - Classroom Security with Deadbolt and Auxiliary Latch | F34 | | |
| | WI8466 - Storeroom | F14 | | |

Optional Interchangeable Cores All keyed lock functions are available with Best, Falcon and Arrow, Schlage, Corbin / Russwin, Sargent, and Yale Large Format Interchangeable Cores

WI Series

HEAVY DUTY, GRADE 1 **WIDE ESCUTCHEON** MORTISE LOCKSET

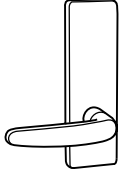
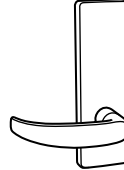
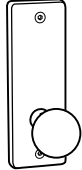
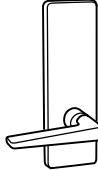
Optional Interchangeable Core Small Format (Best, Falcon and Arrow) or Large Format (Schlage)

| | | | | | |
|---|---|--|---|---|---|
|  |  | Escutcheon Dimension: 2 1/2" x 8 1/4" |  |  |  |
| GE | JE | | KE | VE | YE |

ALL ITEMS BELOW AVAILABLE WITH FACTORY LEAD TIME AND SUBJECT TO MINIMUM ORDER QUANTITY

WIDE ESCUTCHEON GE, JE, KE, VE, YE TRIM ONLY

| FUNCTIONS | | ANSI | FINISHES | |
|---|---|------|----------|-----------------------|
| <i>Single cylinder without deadbolt</i> | WI8050 - Office / Entrance | F04 | US26D | US32D, 32, 10B, 3, 19 |
| | WI8056 - Office with Automatic Unlocking | ---- | | |
| | WI8070 - Classroom | F05 | | |
| | WI8080 - Storeroom | F07 | | |
| <i>Single cylinder with deadbolt</i> | WI8453 - Entrance | F20 | | |
| | WI8456 - Corridor | F13 | | |
| | WI8495 - Keyed Privacy with Indicator | ---- | | |
| | WI8465 - Closet / Storeroom with Deadbolt | ---- | | |
| | WI8473 - Dormitory / Bedroom | F21 | | |
| | WI8480 - Storeroom with Deadbolt | ---- | | |
| <i>Double cylinder without deadbolt</i> | WI8071 - Classroom Security | F32 | | |
| | WI8082 - Asylum / Institution | F30 | | |
| <i>Double cylinder with deadbolt</i> | WI8457 - Classroom Security with Deadbolt | F33 | | |
| | WI8458 - Classroom Security with Deadbolt and Auxiliary Latch | F34 | | |
| | WI8466 - Storeroom | F14 | | |

Optional Interchangeable Cores All keyed lock functions are available with Best, Falcon and Arrow, Schlage, Corbin / Russwin, Sargent, and Yale Large Format Interchangeable Cores

WI Series

HEAVY DUTY, GRADE 1 **WIDE ESCUTCHEON MORTISE LOCKSET**

Optional Interchangeable Core Small Format (Best, Falcon and Arrow) or Large Format (Schlage)

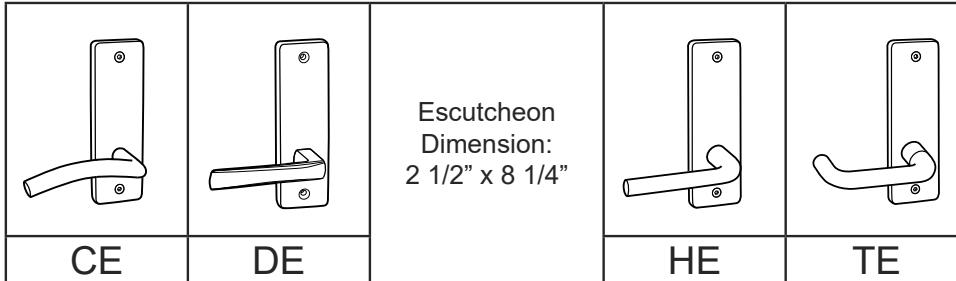

ALL ITEMS BELOW AVAILABLE WITH FACTORY LEAD TIME AND SUBJECT TO MINIMUM ORDER QUANTITY

WIDE ESCUTCHEON CE, DE, HE, TE TRIM ONLY

| FUNCTIONS | | ANSI | FINISHES | | |
|---|---|---|----------|-------|------------------|
| <i>Single cylinder without deadbolt</i> | WI8050 - Office / Entrance | F04 | US26D | US32D | US32, 10B, 3, 19 |
| | WI8056 - Office with Automatic Unlocking | ---- | | | |
| | WI8070 - Classroom | F05 | | | |
| | WI8080 - Storeroom | F07 | | | |
| <i>Single cylinder with deadbolt</i> | WI8453 - Entrance | F20 | | | |
| | WI8456 - Corridor | F13 | | | |
| | WI8495 - Keyed Privacy with Indicator | ---- | | | |
| | WI8465 - Closet / Storeroom with Deadbolt | ---- | | | |
| | WI8473 - Dormitory / Bedroom | F21 | | | |
| | WI8480 - Storeroom with Deadbolt | ---- | | | |
| <i>Double cylinder without deadbolt</i> | WI8071 - Classroom Security | F32 | | | |
| | WI8082 - Asylum / Institution | F30 | | | |
| | <i>Double cylinder with deadbolt</i> | WI8457 - Classroom Security with Deadbolt | | | |
| WI8458 - Classroom Security with Deadbolt and Auxiliary Latch | | F34 | | | |
| WI8466 - Storeroom | | F14 | | | |
| <i>Other Functions</i> | WI8040 - Privacy Bedroom / Bath | F22 | | | |
| | WI8044 - Privacy with Coin Turn Outside | ---- | | | |
| | WI8440 - Privacy with Deadbolt | F19 | | | |
| | WI8444 - Privacy with Deadbolt and Coin Turn Outside | F19A | | | |
| | WI8445 - Privacy with Deadbolt, Coin Turn and Indicator | F19B | | | |
| | WI8010 - Passage | F01 | | | |
| | WI8170 - Single Fixed Dummy | ---- | | | |
| | WI8172 - Double Fixed Dummy | ---- | | | |
| | WI8175 - Single Dummy with Lock Case | ---- | | | |
| | WI8176 - Double Dummy with Lock Case | ---- | | | |

Optional Interchangeable Cores All keyed lock functions are available with Best, Falcon and Arrow, Schlage, Corbin / Russwin, Sargent, and Yale Large Format Interchangeable Cores

NM Series

HEAVY DUTY, GRADE 1 MORTISE DEADBOLTS

Optional Interchangeable Core Small Format (Best, Falcon and Arrow) or Large Format (Schlage)

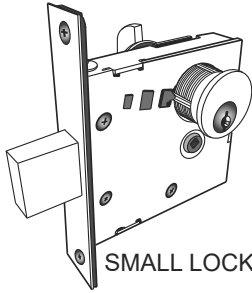

SMALL LOCKCASE

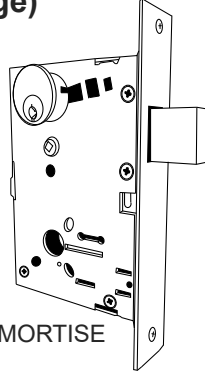

FULL MORTISE



NON-STOCK FINISHES AVAILABLE WITH FACTORY LEAD TIME AND SUBJECT TO MINIMUM ORDER

| MODEL# | ANSI | FINISHES | | FUNCTIONS | MODEL# | ANSI | FINISHES | |
|--------|--------|---------------|---------------------------|--|--------|------|---------------|---------------------------|
| SM4608 | E06071 | US26D, 32D | US10B, 3, 26, 4, 19 | Cylinder and Thumbturn Deadbolt thrown or retracted by key outside or thumbturn inside. | M8460 | F17 | US26D, 32D | US10B, 3, 26, 4, 19 |
| SM4628 | E06061 | | | Double Cylinder Deadbolt operated by key on either side. | M8462 | F16 | | |
| SM4638 | E06091 | | | Classroom Lock Deadbolt thrown or retracted by key from outside. Inside thumbturn cylinder retracts deadbolt but cannot project it. | M8463 | F29 | | |
| SM4648 | E06081 | | | Cylinder Lock Deadbolt thrown or retracted by key from outside only. No trim on opposite side. | M8464 | F18 | | |
| SM4808 | --- | | | Door Bolt Deadbolt thrown or retracted by thumbturn from one side. No trim on opposite side. | M8480 | --- | | |
| SM4968 | --- | | | Deadbolt with "OCCUPIED" indicator Deadbolt thrown or retracted by key outside or thumbturn inside. "OCCUPIED" plate is displayed when deadbolt is thrown. | M8496 | --- | | |

Optional Interchangeable Cores All keyed lock functions are available with **Best, Falcon and Arrow, Schlage, Corbin / Russwin, Sargent, and Yale Large Format Interchangeable Cores**

NM Series

HEAVY DUTY, GRADE 1 MORTISE LOCKSET

► **PACKAGING INCLUDES**

- 6 locks per case
- UL listed single point latch
- Standard "C", 6-pin cylinder
- Non-handed strike

► **KEYWAYS**

6-pin solid brass "C" keyway standard. Optional: Schlage E, Schlage C-K, Russwin D1-2-3-4, Corbin 59 / 60, Arrow A, Corbin-Russwin L4, Sargent LA-LB-LC, Falcon / Weiser E, Yale 8, Yale GA and Kwikset. Can also accept Medeco, Assa, Kaba and **Cal-Royal HSK** High Security Cylinders. See **page L131** for keying and Cylinder PART #.

When using 1 1/8" length Mortise Cylinder (for Sectional trim) and 1 1/4" length Mortise Cylinder (for Escutcheon),

MUST USE CLOVER CAM supplied by Cal-Royal.
Part # KC-S4

► **IC CORE**

All keyed lock functions are available with Small Format and Large Format Interchangeable Cores.

ORDER: Mortise Housing PART # as 2nd Line Item:

- for **Best, Falcon & Arrow SFIC - Part # ICH961387**
- for **Schlage LFIC - Part # 7000ICMC**
- for **Corbin / Russwin LFIC - Part # KM-LFH-CR**
- for **Sargent LFIC - Part # KM-LFH-SA**
- for **Yale LFIC - Part # KM-LFH-YA**

Refer to pages L121 – L122 for Core

► **HOW TO ORDER: IC CORE**
Example: NM8050SSRH US26D with Schlage LFIC,
Order: part # 7000ICMC as 2nd line item

Due to easy reversibility of NM Series, if handing is not available at time of shipment opposite hand will be shipped

STANDARD DISCOUNT ONLY

► **QUICKMARK TEMPLATE**

Available heavy duty steel template for fast and easy installation. Reduces installation time. Eliminates using paper templates.

Part # MTCAL

► **OPTIONAL ADA THUMBTURN**

Prefix "**ADA**" before Mortise lock **ITEM#**
Use **Part # "ADATHUMB"**
when ordering separately.

► **FOR 2" up to 2 1/4" Thick door**

Order kit:
SSMKIT214 - for sectional trim
SEMKIT214 - for escutcheon trim

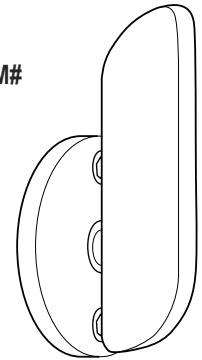

ADA THUMBTURN

► **TACTILE**

- Part # TAC

► **LEAD LINING**

- Part # LEAD

► **ANTI MICROBIAL COATING**

- Available on US26D and US32D finishes.
- Specify "**ANTB**" when ordering.

► **HOW TO ORDER**

NM8050 – SS – RH US26D

| | | | |
|----------------------|---|---|---|
| 1. Office Function | ↑ | ↑ | ↑ |
| 2. SS Trim Sectional | ↑ | ↑ | ↑ |
| 3. Right Hand | ↑ | ↑ | ↑ |
| 4. Satin Chrome | ↑ | ↑ | ↑ |

NM300 Series

ELECTRIFIED MORTISE LOCKS

Available with or without deadbolt

FEATURES:

- UL and CUL Listings
- Continuous duty solenoids for cooler operation during “continuously on” applications
- Low current draw
- Numerous switch options
- 3 year “No Hassle” warranty

OPTIONS:

- Voltage requirement -12V DC or 24V DC
- Amperage - 300mA @ 12V or 130mA @ 24V
- Solenoid coil resistance - 12V = 39.4 Ω or 24V = 173 Ω
- Power consumption - 3.65W @ 12V or 3.3W @ 24V
- Function – available Fail Safe, “Electrically Locked” (EL) or Fail Secure, “Electrically Unlocked” (EU)

► **Optional Switch**

- **RX** – Request to Exit Switch (Monitors the inside handle)
- **LBM** – Latch Bolt Monitoring Switch (Monitors the position of latch bolt)
- **DPS** – Door Position Switch (*Sold Separately. Not installed on the lock.)

HOW TO ORDER ELECTRIFIED NM300 SERIES

- Use **NM Models** if ordered as an **ELECTRIFIED LOCK CASE ONLY**.
- Use **ENM Models** if ordered as a complete lock **with ADD-ON list price**.

Must Specify: NM Series item # and Electrification Option
(*refer to table below*) separately.

For Example: NM8080SSRH US26D with ENM300 (EL 12V) option,
Order: NM8080SSRH US26D and ENM300-RH as two line items.

► **Optional 1.6M Door Cable with Connector**

- **2WC** (2-Wire with connector)
- **4WC** (4-Wire with connector)

► **HANDING: Non-Reversible. Must specify Left Hand (LH) or Right Hand (RH) when ordering.**

**NON-STOCK FINISHES AND FUNCTIONS
AVAILABLE WITH FACTORY LEAD TIME
AND SUBJECT TO MINIMUM ORDER**

| ELECTRIFICATION OPTIONS (WITHOUT DEADBOLT) | | | | | | |
|--|----|----|----|----|----|-----|
| MODEL # | EL | EU | 12 | 24 | RX | LBM |
| ENM300 | ✓ | | ✓ | | | |
| ENM301 | ✓ | | ✓ | | ✓ | |
| ENM302 | ✓ | | ✓ | | | ✓ |
| ENM303 | ✓ | | ✓ | | ✓ | ✓ |
| ENM304 | ✓ | | | ✓ | | |
| ENM305 | ✓ | | | ✓ | ✓ | |
| ENM306 | ✓ | | | ✓ | | ✓ |
| ENM307 | ✓ | | | ✓ | ✓ | ✓ |
| ENM308 | | ✓ | ✓ | | | |
| ENM309 | | ✓ | ✓ | | ✓ | |
| ENM310 | | ✓ | ✓ | | | ✓ |
| ENM311 | | ✓ | ✓ | | ✓ | ✓ |
| ENM312 | | ✓ | | ✓ | | |
| ENM313 | | ✓ | | ✓ | ✓ | |
| ENM314 | | ✓ | | ✓ | | ✓ |
| ENM315 | | ✓ | | ✓ | ✓ | ✓ |

| ELECTRIFIED LOCK CASE ONLY |
|----------------------------|
| MODEL # |
| NM300 |
| NM301 |
| NM302 |
| NM303 |
| NM304 |
| NM305 |
| NM306 |
| NM307 |
| NM308 |
| NM309 |
| NM310 |
| NM311 |
| NM312 |
| NM313 |
| NM314 |
| NM315 |

| ELECTRIFICATION OPTIONS (WITH DEADBOLT) | | | | | | |
|---|----|----|----|----|----|-----|
| MODEL # | EL | EU | 12 | 24 | RX | LBM |
| ENM316 | ✓ | | ✓ | | | |
| ENM317 | ✓ | | ✓ | | ✓ | |
| ENM318 | ✓ | | ✓ | | | ✓ |
| ENM319 | ✓ | | ✓ | | ✓ | ✓ |
| ENM320 | ✓ | | | ✓ | | |
| ENM321 | ✓ | | | ✓ | ✓ | |
| ENM322 | ✓ | | | ✓ | | ✓ |
| ENM323 | ✓ | | | ✓ | ✓ | ✓ |
| ENM324 | | ✓ | ✓ | | | |
| ENM325 | | ✓ | ✓ | | ✓ | |
| ENM326 | | ✓ | ✓ | | | ✓ |
| ENM327 | | ✓ | ✓ | | ✓ | ✓ |
| ENM328 | | ✓ | | ✓ | | |
| ENM329 | | ✓ | | ✓ | ✓ | |
| ENM330 | | ✓ | | ✓ | | ✓ |
| ENM331 | | ✓ | | ✓ | ✓ | ✓ |

| ELECTRIFIED LOCK CASE ONLY |
|----------------------------|
| MODEL # |
| NM316 |
| NM317 |
| NM318 |
| NM319 |
| NM320 |
| NM321 |
| NM322 |
| NM323 |
| NM324 |
| NM325 |
| NM326 |
| NM327 |
| NM328 |
| NM329 |
| NM330 |
| NM331 |

► *Electrified Mortise Lock Case can be purchased separately. Refer to table above for options.*

► *See pages L1-L15 for NM Series mortise lock stock functions and finishes.*